



BRIDGEPOINT SYSTEMS



120 Volt Electric Thermal Energy System Operator's Manual

E-TES SD



Bridgepoint Systems
4282 South 590 West
Salt Lake City, UT 84123
801-261-1282 | 801-268-3856 fax

"E-TES - World's Fastest Drying System"™

Table of Contents

Introduction	3
General Information	4

SECTION 1

Heater Operation Safety	6
-------------------------	---

SECTION 2

Menu Navigation	7
Remote Probe Set-up	11
Air Mover Set-up	14
Remote Fan Control	15
Dual Circuit Indicator	16
Software Updates	17
Data Charting	18

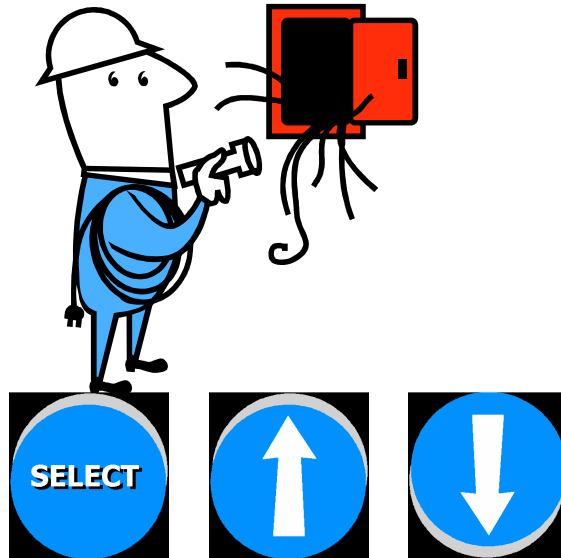

SECTION 3

Drying Carpet	21
Drying Wood Floors	23
Drying Walls	25



SECTION 4

Heater Operation	27
Troubleshooting	30
Re-initializing Memory	35
Resetting Processor	37
Wiring Diagrams	38

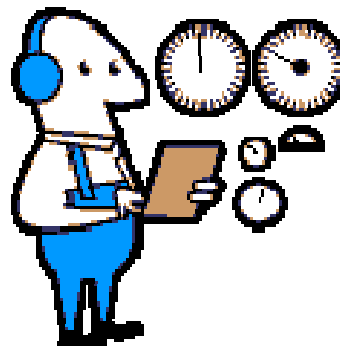

SECTION 5

Maintenance	41
Parts	42
Warranty	47

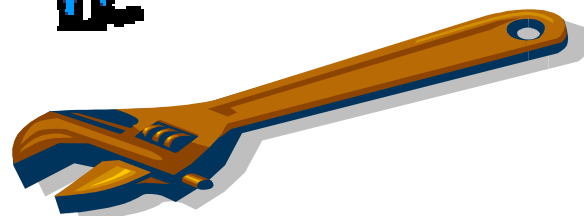

Introduction

Congratulations on your purchase of the Bridgepoint Systems E-TES SD 120 Volt Electric Thermal Energy System. This manual is a guide for safe operation and maintenance of this unit.

Read and understand this manual completely before operating this unit.

This manual should be maintained in legible condition adjacent to the unit or in a secure location for future reference.

Any questions pertaining to the operating or servicing of this unit should be directed to your nearest Bridgepoint Systems distributor.

Warning: Improper operation, alteration, service or maintenance can cause property damage, personal injury or loss of life. Service must be performed by a qualified technician, service agency or electrician. Bridgepoint Systems is in no way responsible and is excluded from liability in respect to any loss or damage which may arise due to improper operation, maintenance or repair.

This manual is written specifically for the E-TES SD 120 Volt Electric Thermal Exchange units manufactured by:

Bridgepoint Systems
4282 S 590 W
Salt Lake City, UT 84123
801-261-1282

Information in this manual is subject to change without notice and does not represent a commitment on the part of Bridgepoint Systems.

General Information

E-TES SD 120 Volt ELECTRIC THERMAL ENERGY SYSTEM

10,230 Btu 120vac Electric Model

Height: 19-7/8"
 Length: 24"
 Width: 20-5/8"
 Weight: 39 lbs.
 Heater watt rating: 3000 watts
 Cord 1 Amp Draw: 12amps
 Cord 2 Amp Draw: 12amps



NM4407



NM4407

E-TES SD 120 Volt Standard Equipment ELECTRIC THERMAL EXCHANGE UNIT

NM4407 (2) 50' - 12/3 GFCI Power Cords w/ 5-15P & 5-15R ends

SMART E-TES SD 120 Volt Optional Sensors & Controls

ST001 E-TES Charter Software (Purchased online at tesdryingsystem.com)

AT210 E-TES SD Smart Package
 Smart Package includes:

(1) AT200, (1) AT202, (1) PGE5060, (2) AT204, (1) AT206 & (1) AT208

AT200 Surface Temperature Sensor w/ 10ft cord

AT202 Air Temperature Sensor w/ 10ft cord

PGE5060 Moisture Level Sensor w/ 4ft cord

AT204 10 ft sensor extension cord M-F jack & plug

AT206 Remote Exhaust Controller

AT208 Travel Bag for Sensor Storage

AC102 Hammer Probe w/ 4ft cord



AT206



AT204



AT202



AT200



AC102



PGE5060



AT208

Additional / Optional Equipment

- AX33** 50' - 12/3 Extension Cord w/ 5-15P & 5-15R
- AC262A** Layflat Ducting 14" Dia. (22.5" flat) x 500'
- AT56** Duct Ring 14"
- AC25A** Omni Dry 2.9 Centrifugal Air Mover
- AC246** OmniDry Focal Point Axial Air Mover
- AC128** SureTest Circuit Analyzer
- AX49** Breaker Buddy
- MB230** Single Stage Exhaust Controller
- AC512** Octi-Dry
- MI22** Injectidry HP60FDP Floor Drying Package



AX33



AC25A



AC246



AC512



MI22



AT56



MB230



AX49



AC128

Heater Operation Safety

- **Always use the Ground Fault Circuit Interrupting (GFCI) cords to reduce the risk of electrical shock.**
- **DO NOT** use E-TES SD in standing water.
- Examine the electric outlets before connecting your E-TES. Loose fitting or damaged outlets can cause the power cords to overheat. Do not use loose fitting or damaged outlets. If necessary, have an electrician repair the outlets before connecting your E-TES to prevent cord damage.
- The power outlets must be wired and have circuit breaker sized to safely handle the rated amperage of the unit. The two cords must be on separate circuits. Use a Breaker Buddy to determine if outlets are on separate circuits.
- Connect GFCI cords to the power outlet. One additional 12/3 x 50 foot extension cord may be placed between GFCI cord and E-TES SD 120 volt unit. No more than two cords (100ft. total cord length) may be used. Use only 12 gauge cords.
- Never operate this heater with a damaged power cord. Do not permit cord to contact carpet tacks or other sharp objects or to become damaged by closed doors or otherwise abused. If the power cord is damaged it must be replaced.
- Keep cord connections off wet floors. Protect cord connections from damp surfaces and water sources. Wear rubber boots and rubber gloves when handling heater and cords in damp conditions.
- Turn E-TES unit heater switch OFF before connecting or disconnecting cord to unit. Unplug machine power cord from outlet before performing any repair on the heater.
- To reduce the risk of property damage or injury, repairs to electrical systems should only be performed by experienced technicians. Contact your nearest service center for assistance.
- **Always turn Heater OFF and keep air mover running for 5 minutes to cool heater before turning air mover OFF.** If air flow is turned off and the unit is not cooled properly the heater box and front grill may get very hot, creating a burn hazard or damaging the unit.
- Heater snout must be in the horizontal position or directed up. The snout cannot be directed down. Directing the snout down will make the air flow switch inoperable, may result in damage to heater and will void warranty.
- Do not operate this heater unless all panels and guards are in place and properly secured.
- Adequate air flow must be maintained across heating elements for proper, safe operation. Do not disable airflow switch or other safety switches, doing so may result in damage to heater and will void warranty.
- Remove Feet or carpet clamps from snout of air mover before placing air mover into E-TES Electric Thermal Exchanger to prevent damage to air seal gasket.

Navigation – Remote Sensor Set-up & Data Charting

E-TES SD MENU NAVIGATION:

With the GFCI reset and the power cord connected to the E-TES SD, turn power switch to the ON position. Display will quickly scroll through the first six screens, before stopping at the Main Screen.

First screen:

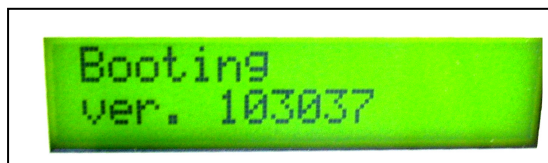

Booting Screen
Software version booting up

Second screen:



Welcome Screen

Third screen:

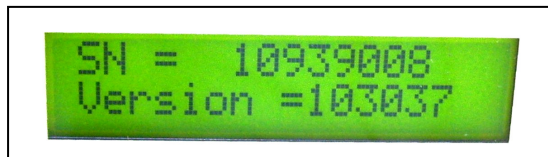

Unit serial number and software version

Fourth screen:

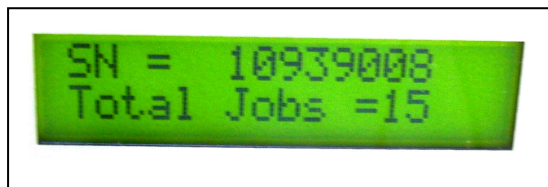

Unit serial number and number of jobs logged

Fifth screen:



Directions for how to view menus

Sixth screen:



Directions for how to enter menus to change settings

MAIN SCREEN:

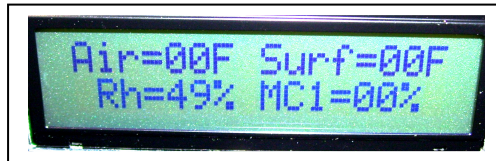

Main screen will display current probe temperatures or default settings if no probes are connected.

- Air Default Setting: 00F
- Surface Default Setting: 00F
- Moisture 1 Default Setting: 00%
- Rh (Relative Humidity): Current value

Press **UP** / **DOWN** to move from Main Screen and scroll through Menu

From the Main Screen

PRESS DOWN: TO ACCESS AIR TEMPERATURE SCREEN

OR

PRESS UP: TO CURRENT DATE & TIME SCREEN

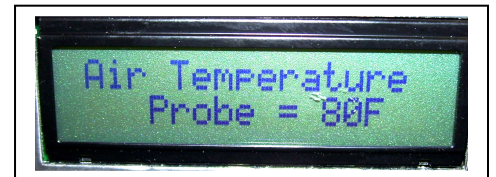

Air Temperature Screen: This tells you the current reading of the Air Temperature Sensor probe if it is connected to the E-TES SD or the default value of 00F if the probe is not connected.

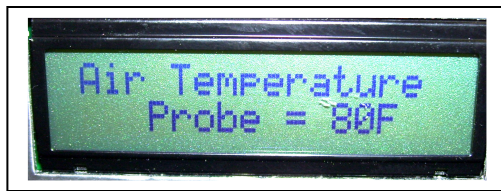

Press **SELECT** to set Air Temperature Probe shutdown temperature. Use **UP/DOWN** to change Air Temperature shutoff setting.

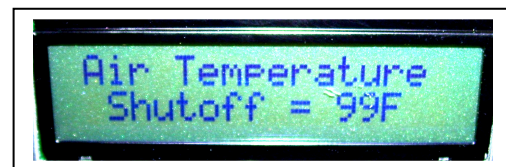

- Press **DOWN** to move to Surface Temp Screen
- Press **UP** to return to Main Screen

Surface Temperature Screen: This tells you the current reading of the Surface Temperature Sensor probe if it is connected to the E-TES SD or the default value of 00F if the probe is not connected.

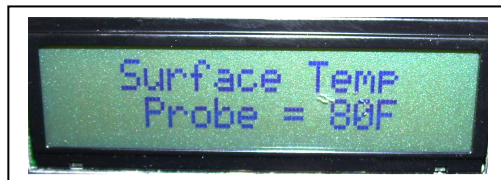

Press **SELECT** to set Surface Temperature Probe shutdown temperature. Use **UP/DOWN** to change Surface Temperature shutoff setting.

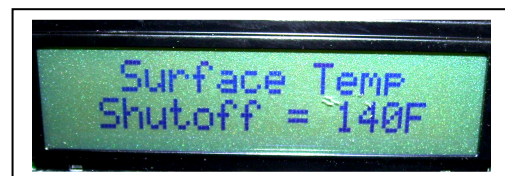

- Press **DOWN** to move to Moisture 1 Value Screen
- Press **UP** to return to Air Temperature Screen

Moisture 1 Value Screen: This tells you the current reading of the Moisture probe if it is connected to the E-TES SD or the default value of 00% if the probe is not connected.

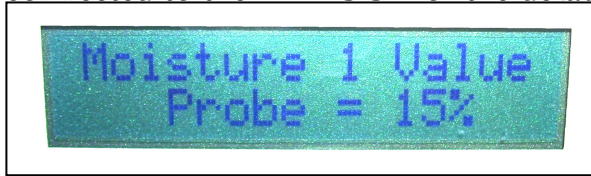

Press **SELECT** to set Moisture Probe shutdown percentage. Use **UP/DOWN** to change moisture percentage level set point.

- Press **DOWN** to move to Moisture 2 Value Screen
- Press **UP** to return to Surface Temp Screen

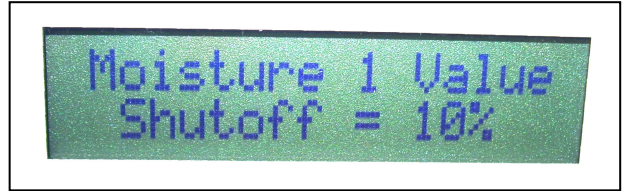

UNIT WILL NOT SHUTOFF IF SET BELOW 10%

Moisture 2 Value Screen: This tells you the current reading of the Moisture probe if it is connected to the E-TES SD or the default value of 00% if the probe is not connected.

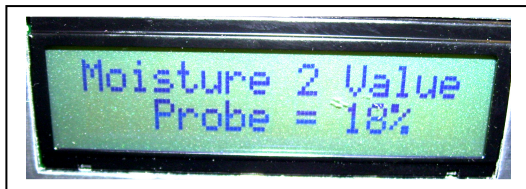

Press **SELECT** to set Moisture Probe shutdown percentage. Use **UP/DOWN** to change moisture percentage level set point.

- Press **UP** to return to Moisture 1 Value Screen



UNIT WILL NOT SHUTOFF IF SET BELOW 10%

- Press **DOWN** to move to Humidity / Internal Temperature Screen

Humidity / Internal Temperature Screen: This tells you the relative humidity percentage and temperature inside the E-TES SD box.

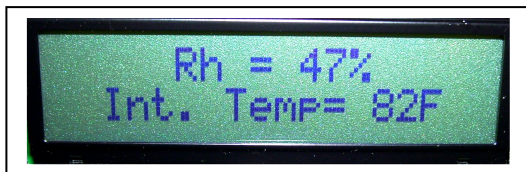

- Press **DOWN** to move to Remote Setup screen
- Press **UP** to return to Moisture 2 Value screen

Remote Setup Screen: This allows you to set temperature at which the E-TES SD will turn on Remote Exhaust Controller. (Remote Air Temperature Sensor to operate remote control.)



Press **SELECT** to set the E-TES Remote Exhaust Controller turn on temperature. Use **UP/DOWN** to change temperature.

- Press **DOWN** to move to Air Flow Setup Screen
- Press **UP** to return to Humidity Internal Temperature Screen



Air Flow Setup Screen: This allows you to recalibrate the Air Flow switch to maintain proper air flow switch function for reliable heater operation.



Press **SELECT** to set the Air Flow switch trigger point. Follow the screen directions using the **DOWN** button to set the levels with the air mover OFF & ON.

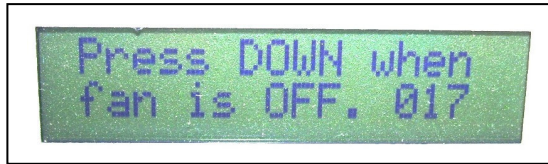

1. First turn the air mover OFF. When the fan is off and the number stops changing, press **DOWN**. This is the Off Set Point. (Shown as 017 in this example)
2. Then turn the air mover ON at low speed. Press **DOWN** as soon as the fan on number is about 50 points higher than the Off Set Point. This is the ON Set Point. (Shown as 067 in this example)
3. The Air Flow Trigger point is now set. The Air Flow Trigger is approximately half way between the Off Set Point and the On Set Point. (Shown as 043 in this example)

- Press **DOWN** to move to the Current Job Time Screen.
- Press **UP** to return to the Remote Setup Screen

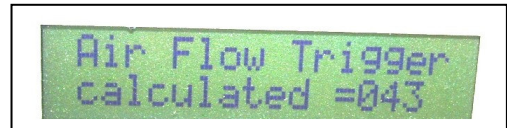

Current Job Time Screen: This shows the time the system has run since the switch was last turned on.



- Press **DOWN** to move to Total System Time Screen
- Press **UP** to return to Air Flow Setup Screen

Total System Time Screen: This shows the total time the system has been run on all jobs.



- Press **DOWN** to move to Date & Time Screen
- Press **UP** to return to Current Job Time Screen

Current Date and Time Screen



Press **SELECT** to set the E-TES SD Date & Time Clock. HOUR will flash first. Use the **UP/DOWN** buttons to change the HOUR setting. When correct, press **SELECT** to move to MINUTES, then SECONDS, MONTH, DAY NUMBER & finally YEAR. Use **UP/DOWN** to change each setting and **SELECT** to move to next option. When correct, press **SELECT** to save setting

- Press **DOWN** to return to Main Screen
- Press **UP** to return to Total System Time Screen

(The DAY will change as you change MONTH, DAY NUMBER or YEAR.)

E-TES SD REMOTE SENSOR - PROBE CONNECTION:

E-TES SD can be operated without using the optional remote sensors.

The Main Screen will display current probe temperatures or default settings if no probes are connected. The shutdowns controlled by the probes will not turn off the power to the heating elements if the probes are not connected.

- Air Temperature Probe Default Setting: 00F
- Surface Temperature Probe Default Setting: 00F
- Moisture 1 Value Default Setting: 00%
- Moisture 2 Value Default Setting: 00%

To use the remote temperature or moisture probes to control the E-TES SD, simply plug the desired remote sensor in the corresponding port on the front panel of the E-TES SD. Return to the MENU NAVIGATION section to set the shutdown points for each probe.

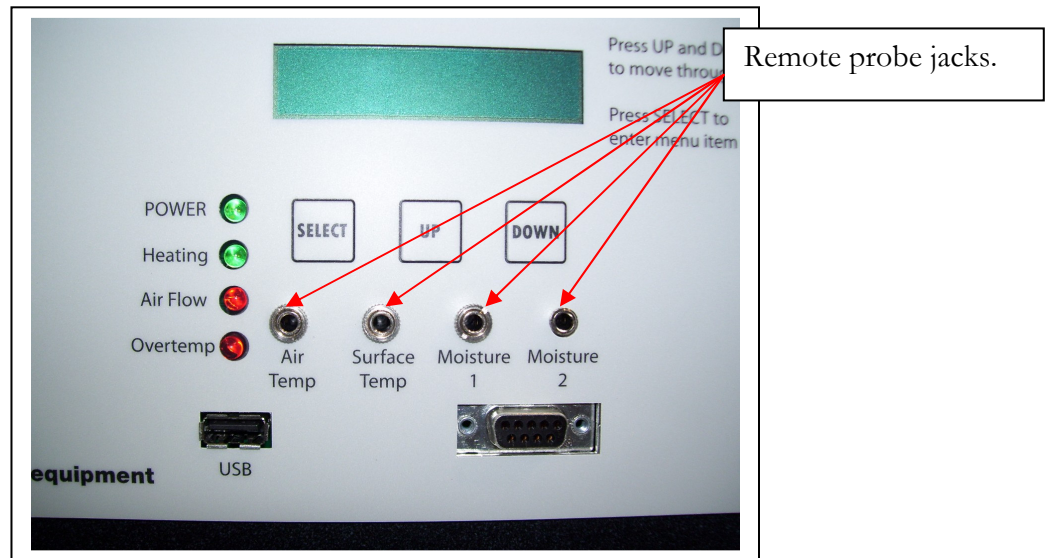

Moisture Probe with 4' cord
PGE5060



Surface Temperature Probe
with 10' cord - AT200



Air Temperature Probe with
10' cord - AT202



Moisture Hammer Probe with
4' cord - AC102



10' extension cord - AT204
Can be used with any of the E-TES probes

REMOTE PROBE SHUTDOWN:

If the measured readings of any of the remote probes exceed the set points, the green HEATING light will turn off, indicating the unit is no longer heating.

AIR TEMPERATURE SHUTOFF

When the AIR TEMPERATURE measured by the probe exceeds the set point the green HEATING light will turn off indicating unit has shutoff the power to the heating elements.

The AIR TEMPERATURE screen will be displayed, flashing the current temperature and the shutoff temperature set point.

When the temperature cools sufficiently the green HEATING light will turn back on and the unit will again heat up.

The AIR TEMPERATURE SHUTOFF will not shutoff the power to the heating elements if the AIR TEMPERATURE probe is not connected.

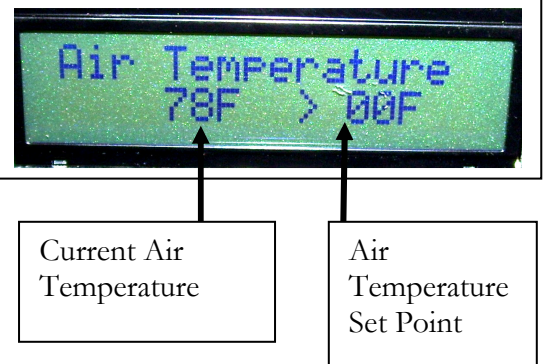

SURFACE TEMPERATURE SHUTOFF

When the SURFACE TEMPERATURE measured by the probe exceeds the set point the green HEATING light will turn off indicating unit has shutoff the power to the heating elements.

The SURFACE TEMPERATURE screen will be displayed, flashing the current temperature and the shutoff temperature set point.

When the temperature cools sufficiently the green HEATING light will turn back on and the unit will again heat up.

The SURFACE TEMPERATURE SHUTOFF will not shutoff the power to the heating elements if the SURFACE TEMPERATURE probe is not connected.

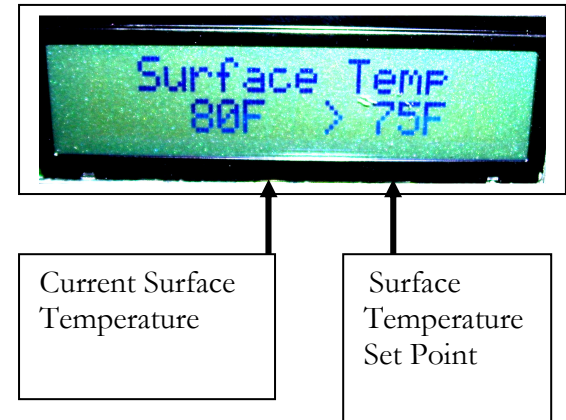

MOISTURE 1 VALUE SHUTOFF

When the MOISTURE 1 VALUE measured by the probe drops below the set point the green HEATING light will turn off indicating unit has shutoff the power to the heating elements. The MOISTURE 1 VALUE screen will be displayed, flashing the current moisture percentage and the shutoff moisture value percentage set point.

If the moisture level rises sufficiently the green HEATING light will turn back on and the unit will again heat up.

The MOISTURE 1 VALUE SHUTOFF **will not** shutoff the power to the heating elements if the MOISTURE 1 probe is not connected.

If the E-TES SD is ON when the Moisture 1 Probe is connected, the MOISTURE 1 VALUE SHUTOFF **will** shutoff the power to the heating elements even if the MOISTURE 1 VALUE is above the set point. The power switch must be turned OFF & back ON to reset E-TES to read the correct the moisture value and allow power to the heating elements.

Do not plug-in or unplug the Moisture Probes while the E-TES SD is ON. Turn E-TES OFF before plugging in or un-plugging Moisture Probes, then turn unit back ON.

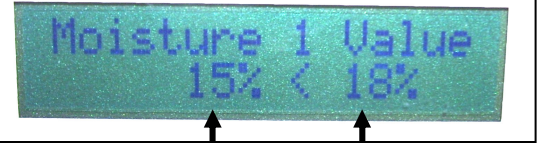

Current Moisture Level

Moisture Value Set Point

To assure that the E-TES SD will shut off & stay off when the Moisture 1 Value drops below the shutoff value, the Moisture Value 1 Shutoff **MUST NOT** be set below 10%.

To chart the Moisture 1 Value without controlling the E-TES SD set the Moisture Value 1 Shutoff to 0%.

MOISTURE 2 VALUE SHUTOFF

When the MOISTURE 2 VALUE measured by the probe drops below the set point the green HEATING light will turn off indicating unit has shutoff the power to the heating elements. The MOISTURE 2 VALUE screen will be displayed, flashing the current moisture percentage and the shutoff moisture value percentage set point.

If the moisture level rises sufficiently the green HEATING light will turn back on and the unit will again heat up.

The MOISTURE 2 VALUE SHUTOFF **will not** shutoff the power to the heating elements if the MOISTURE 2 probe is not connected.

If the E-TES SD is ON when the Moisture 2 Probe is connected, the MOISTURE 2 VALUE SHUTOFF **will** shutoff the power to the heating elements even if the MOISTURE 2 VALUE is above the set point. The power switch must be turned OFF & back ON to reset E-TES SD to read the correct the moisture value and allow power to the heating elements.

Do not plug-in or unplug the Moisture Probes while the E-TES SD is ON. Turn E-TES OFF before plugging in or un-plugging Moisture Probes, then turn unit back ON.



Current Moisture Level

Moisture Value Set Point

To assure that the E-TES SD will shut off & stay off when the Moisture 2 Value drops below the shutoff value, the Moisture Value 2 Shutoff **MUST NOT** be set below 10%.

To chart the Moisture 2 Value without controlling the E-TES SD set the Moisture Value 2 Shutoff to 0%.

E-TES SD AIR MOVER SET-UP

For continuous reliable operation of the new E-TES SD the Air Flow Sensor must sense and measure the air flow from the air mover to know when the heater should turn on and off.

Part of this process involves the proper placement of the air mover in the E-TES SD box.

The measured range of air flow can vary greatly with small changes in the direction of the air flow from the air mover snout. A more narrow range of air flow detection may not matter in open flow operation, but when the E-TES SD output air flow is restricted by ducting or the weight of a carpet being floated a narrow range may cause the heater to turn on & off during operation.

To get the best Air Flow Sensor operation and widest range of measurement make sure the snout of the air mover points toward the front of the E-TES SD.

Air Mover Installation:

Place the snout of the air mover through the sealing gasket into the opening on the top of the E-TES SD. Once the snout is inside the opening, rotate the air mover to point the snout toward the front of the E-TES SD. Different models of air movers will sit differently on the top of the E-TES SD box. If needed, a foam furniture block, a folded towel or other object can be used as a spacer between the air mover and the support cradle on top of the box to maintain the proper alignment.

If the E-TES SD is to be pointed up the towel or other spacer is placed under the top of the E-TES SD box raise it up off of the floor and allow the air mover snout to maintain the proper air flow angle.

Connect ducting, Octidry, snout adapter with ducts, or place the E-TES SD snout under the carpet to be floated before calibrating the air flow sensor. Refer to page 10 for calibration instructions or contact you E-TES SD distributor.

Foam Blocks used as spacer



Snout Angled Forward



Snout Not Angled Properly

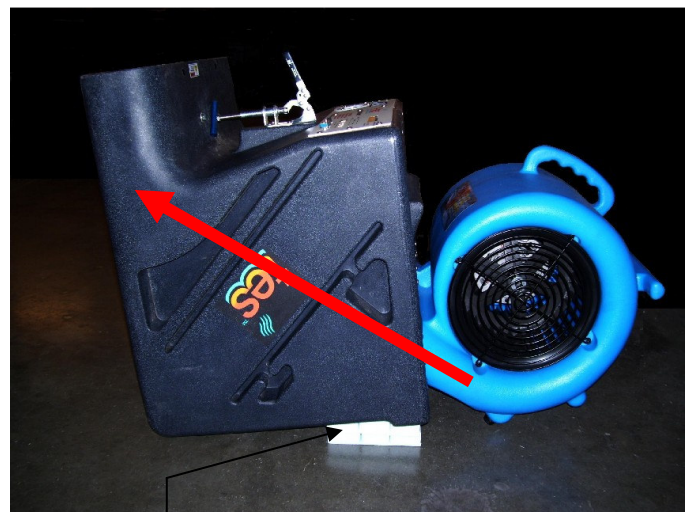

Snout Angled Up

REMOTE EXHAUST CONTROLLER:



This allows you to set the temperature at which the E-TES SD will send a signal to turn on a remote exhaust fan. The Remote Exhaust Controller can be located up to 100 yards away from the E-TES SD unit and control electrical devices with a total amp load up to 15amps.

The Remote Air Temperature Sensor must be connected to operate the Remote Exhaust Controller.

Plug the Remote Exhaust Controller into a 120VAC wall outlet and then plug your exhaust fan into the Remote Exhaust Fan Control. Turn the exhaust fan switch to the ON position. When the air temperature reaches the set point the E-TES SD will activate the Remote Exhaust Fan Control to send power to the exhaust fan to turn it on.

To adjust the set point use the **UP & DOWN** arrow keys to move to the REMOTE SETUP screen. Press - **SELECT** to enter the temperature setup screen and use the **UP & DOWN** arrows to set the Remote Exhaust Controller turn on temperature.



The Remote Exhaust Controller must be calibrated to work with the signal from a specific E-TES SD. To calibrate the Remote Exhaust Controller:

1. Push the reset button on the Controller as you plug the Controller into the wall outlet. This will clear the memory of the control.
2. Turn the E-TES SD unit on and scroll to the REMOTE SETUP screen then press select.
3. Use the UP & DOWN arrows to set the Remote Exhaust Controller turn on temperature. This will send a signal to calibrate the Remote Exhaust Controller.

RESET BUTTON

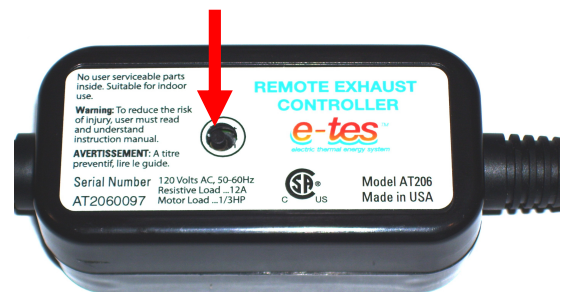

If you are using multiple E-TES SD units with multiple remotes, turn the other E-TES SD units OFF as you calibrate each remote to a specific E-TES SD to prevent signals from the other units from interrupting your calibration.

DUAL CIRCUIT INDICATOR:

The amp draw of the two circuits of the E-TES SD 120 Volt unit requires that the two power cords be plugged into separate outlets. To assist you in determining if the cords are plugged into separate circuits, The E-TES SD 120 Volt unit is now equipped with a dual circuit indicator.

With both power cords plugged into outlets, connected to the E-TES SD 120 Volt unit and the GFCI's reset, turn E-TES SD unit power switch to the ON position. Observe Dual Circuit indicator light next to rocker switch. If green light is ON, cords are on separate circuits and you can proceed with set-up. If light is OFF both cords are on the same circuit and one cord must be moved, one cord is not supplying power. Display will light, Power & Heating lights may turn ON if Cord #1 has power even if Cord #2 is disconnected. Both cords must be connected and Dual circuit indicator light must be ON for proper heater operation.

When cords are on separate circuits and green Dual Circuit indicator light is on proceed with set-up.

Improper wiring of electrical outlets can prevent the indicator light from turning on. Using an overloaded circuit may cause the circuit breaker to blow even if both cords are on separate circuits.

An AX128 SureTest Circuit Analyzer can be used to test the outlet wiring and existing load to reduce the chances of the circuit breakers tripping during E-TES SD operation.

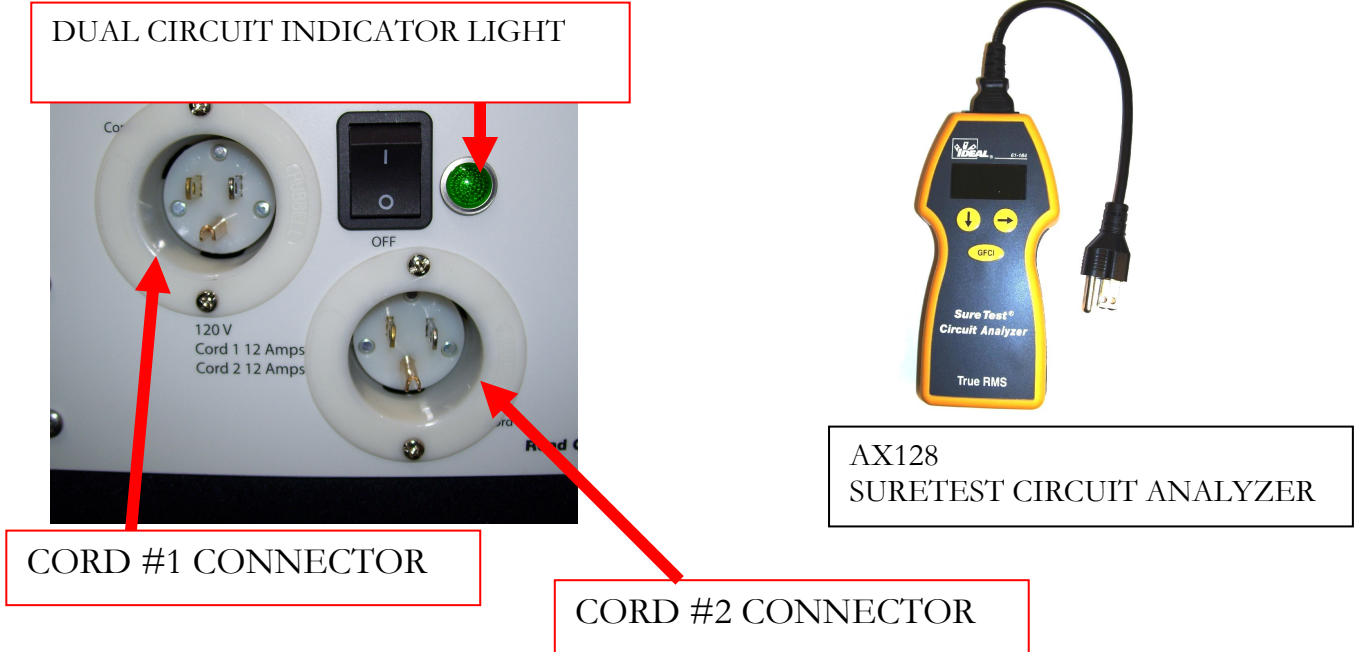

With Cord #2 disconnected or connected to a dead outlet, as long as there is power to Cord #1 and Cord #1 is connected to the E-TES SD 120 Volt unit, the LED display and the POWER & HEATING indicator lights will still function, but the heater will only operate at one half of its rated heating capacity.

SOFTWARE UPDATES:

The E-TES SD software can be reprogrammed or updated using a removable data storage device such as an USB Flash Drive or Memory Stick. When software updates are available you will be contacted by your distributor. You will receive a Flash Drive preloaded with the new software or the software can be e-mailed to you to be downloaded onto your own Flash Drive or Memory Stick.

To update the E-TES SD software, simply plug the memory device, with the E-TES SD software file, into USB port on front panel, turn switch ON and the software will automatically be updated. The display will read UPDATE along with the old version and new version numbers. The screen will not change until the update is complete.

Then remove the memory device and turn the switch off.

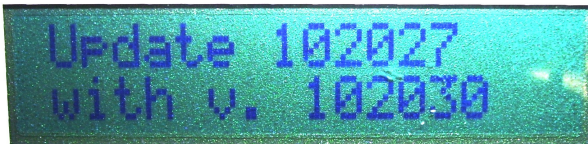
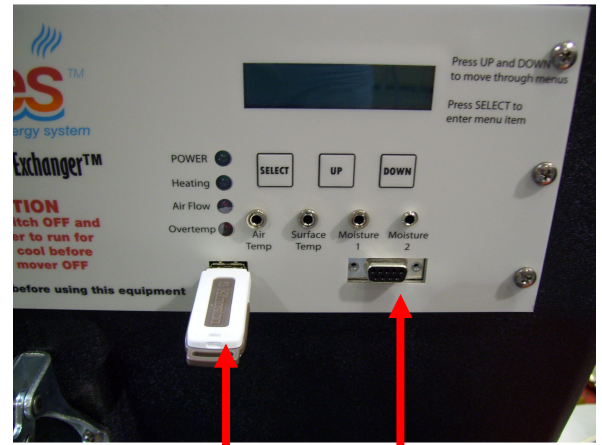

SOFTWARE UPDATE SCREEN

Shows the old software version number and the version number of the new software which is replacing the old version

REMOVABLE USB
MEMORY DEVICE

Computer Serial Port for E-TES SD
manufacturer use only, used for testing
and formatting of microprocessor

If your USB Flash Drive is protected by a password, you will need to temporarily disable the password to connect it to the E-TES SD. This goes for installing the activation key, installing updates, and downloading the job data.

From our tests it was not necessary to disable the Flash Drive's auto-run programs, such as the SanDisk U3 Launchpad to work with the E-TES SD.

DATA CHARTING:

The E-TES SD now has the ability to measure and store data regarding the operating status of the unit and the environmental conditions during the drying process. The E-TES SD will hold up to one month of continuous operational data. The Charter data is sorted by the serial number of each unit and each job is given a file number so one USB Flash Drive can be used for multiple E-TES SD units.

Optional E-TES Charter Software, Item # ST001, is required to download, read and graph the data log information. The Charter software and E-TES SD data logging activation key must be purchased separately online at tesdryingsystem.com.

Once you have purchased the activation key, this data can be retrieved by inserting a removable data storage device such as a Flash Drive or Memory Stick into the USB port on front panel. Turn the power switch ON to log data from the E-TES SD unit. When Flash Drive stops flashing, and the **Updating USB - Do Not Remove** screen is no longer showing, turn the switch off and remove the Flash Drive. Flash Drive can then be connected to the USB port on your computer to download the data.

The E-TES Charter software will allow you to compile reports for insurance adjusters or homeowners to support your drying procedures and billing. On the E-TES Charter preview screen you can modify the graph by clicking on the keys at the bottom of the screen to add or delete different data you want displayed on your graph.

The job can be named and data is exported to Excel to create job files, graphs and reports. Multiple job files can be joined to create a new single job file for reports.

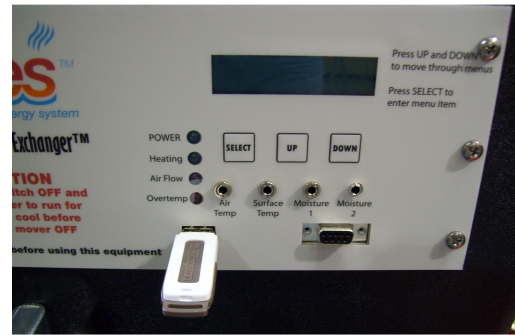

ACTIVATION KEY ENTERED AND DATA
RETRIEVED USING A REMOVABLE USB
MEMORY DEVICE

E-TES Charter Preview Screen

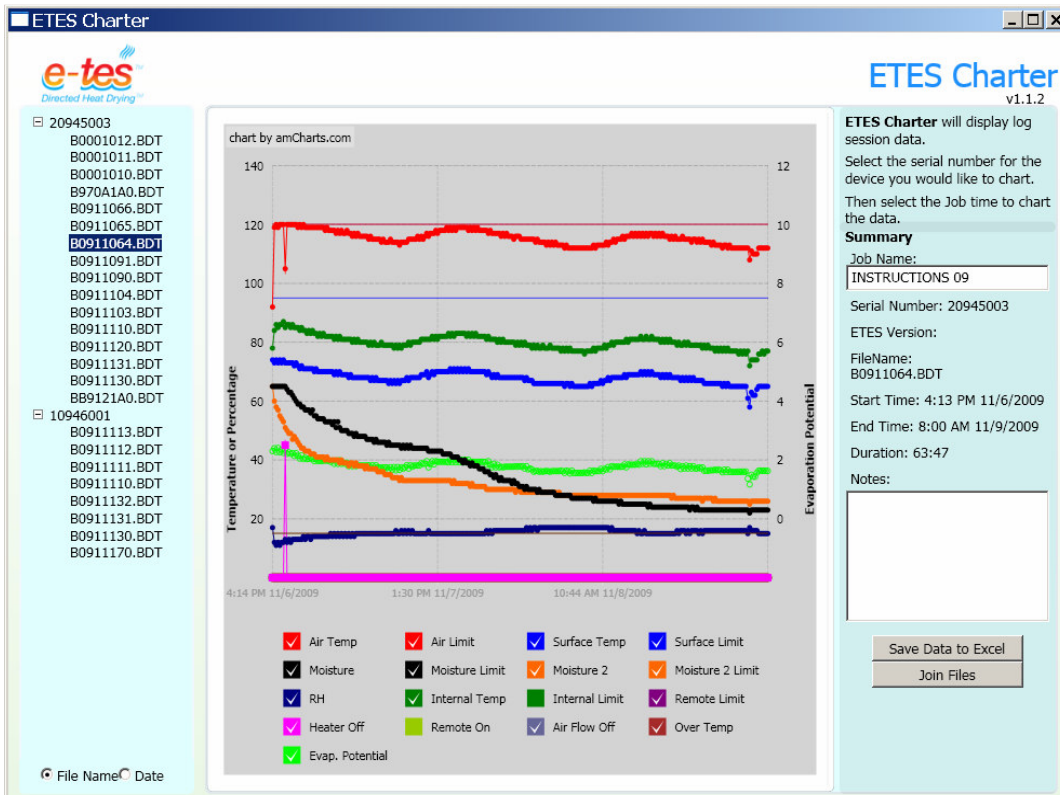

The jobs files are sorted by the serial number of the E-TES SD unit from which the data was retrieved. Serial numbers starting with “2” are 240 volt units and serial numbers starting with “1” are 120 volt units. The jobs are listed by either file name or date. Select File Name or Date at the bottom of the page to determine how the jobs will be displayed. When changing from File Name or Date an error message may be displayed on your computer. Just click continue and the Charter will re-open and display as you selected. In the example on the previous page the job file names are listed. The file names such as B0911064 consist of the year, month and day the job was started and a number to differentiate various jobs started on the same day. The example below shows the job files displayed by date.

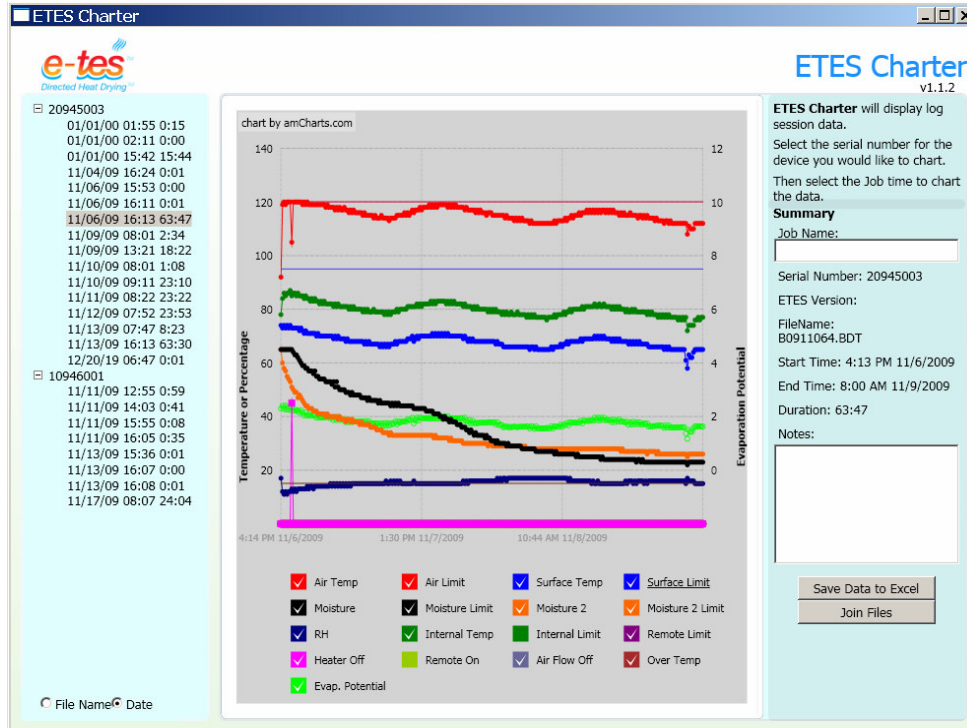

By moving your cursor over the graph it will display flags with the readings for individual points on the graph lines, as shown in the example below.

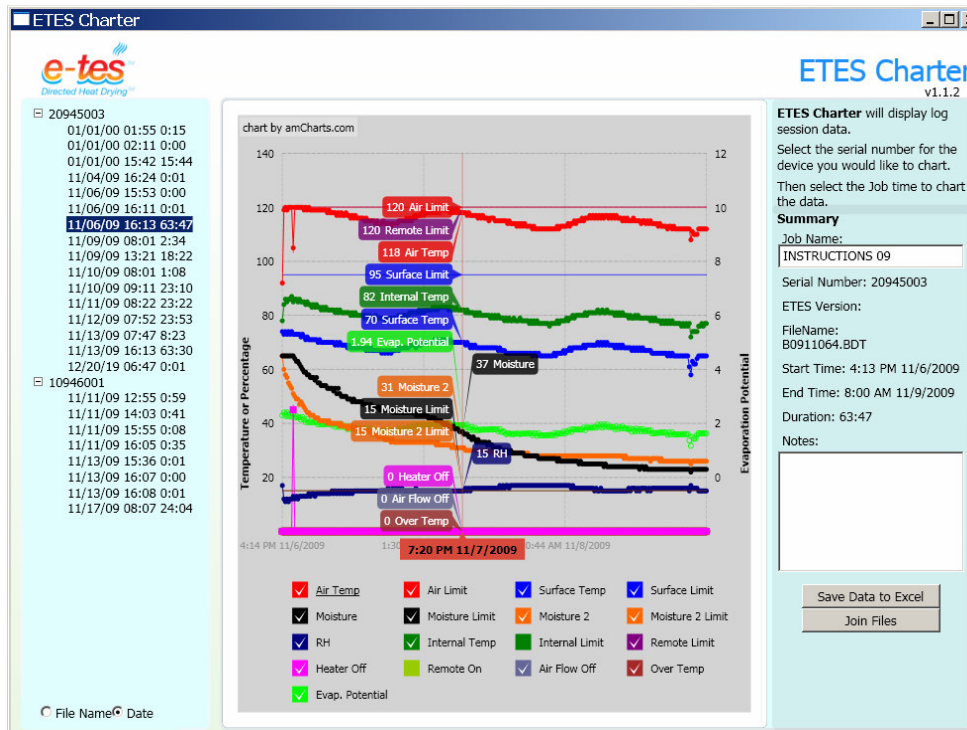

In this example of an Excel graph, you can see that the AIR TEMPERATURE LIMIT and REMOTE LIMIT were set at 120°F, the SURFACE TEMPERATURE LIMIT was set at 95°F, and the MOISTURE 1 LIMIT and MOISTURE 2 LIMIT were set at 15%. The RH or Relative humidity stayed around 15 to 20%. The INTERNAL TEMPERATURE stayed around 80-90°F. The E-TES unit never had the AIR FLOW turn off or an OVERTEMP condition.

The AIR TEMPERATURE PROBE reading exceeded the limit twice and turned the heater off for two short periods. When the air temperature cooled the heater turned back on both times.

The moisture content of the wood started over 60%. The MOISTURE 1 VALUE and MOISTURE 2 VALUE both dropped but stayed above the 15% limit and did not shut the heater off.

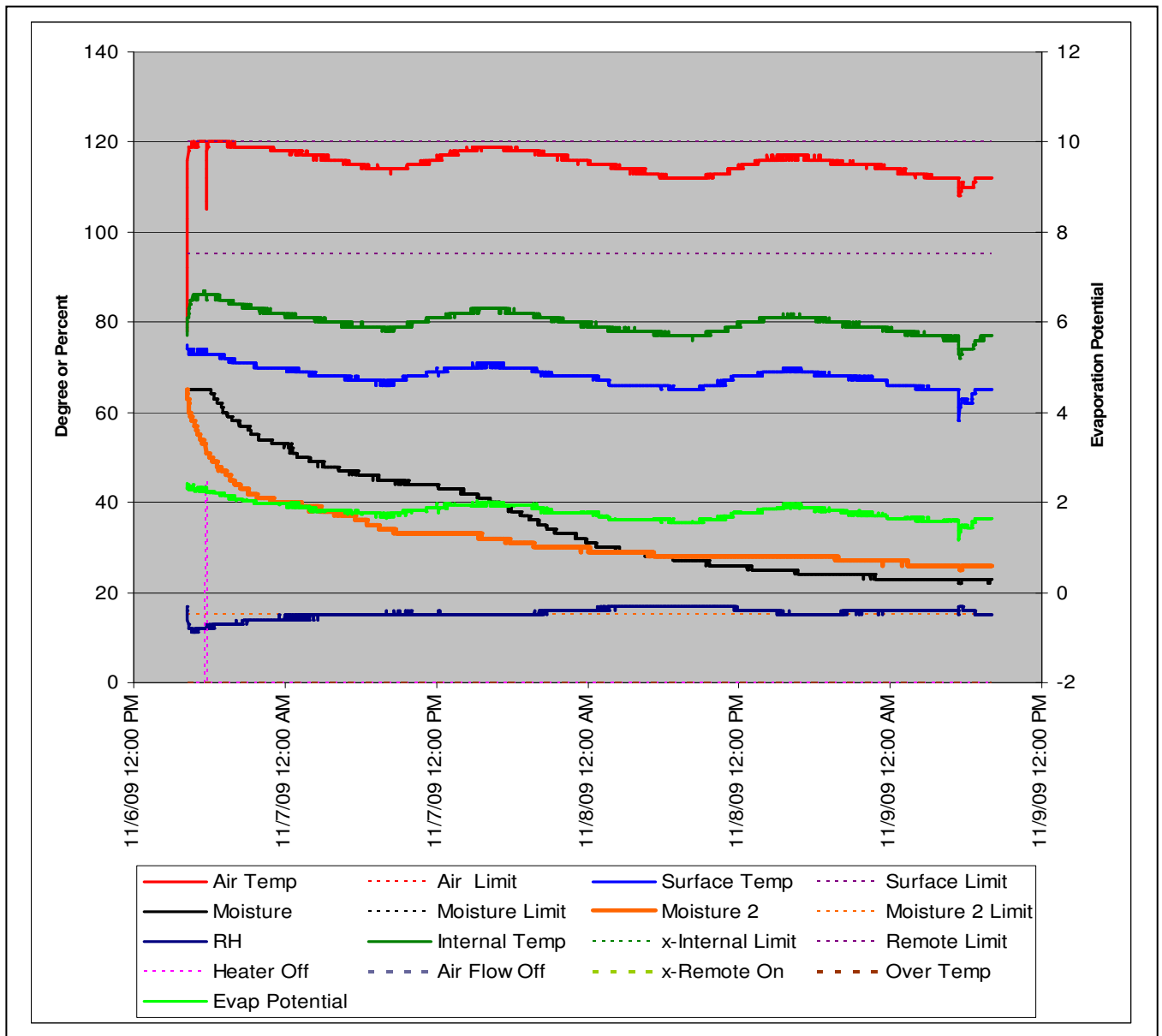

You can modify the graph to chart the readings which you decide are the most relevant to each job. For this chart: the following changes were made in the graph:

- The REMOTE ON was not charted.
- The INTERNAL LIMIT was not charted.

Heater Set-up Procedures

The best way to dry wet carpet, hardwood floors and walls is to implement the Reets Evaporation Method utilizing your E-TES SD unit. The following steps will explain how to this method can be applied for drying different surfaces.

Carpet Drying Procedure

Step #1 – Extraction

1. This is the key for any drying. Extract as much of the water as possible with your portable or truck mounted equipment. A weighted extraction tool will compress the padding and carpet to remove more water. The more you remove with extraction, the faster the carpet will dry. Test extraction by squeezing the pad in your hand. Continue extracting until no more water can be squeezed out. If this level of extraction cannot be achieved, remove the pad.

Step #2 - Energy applied directly to the water (Temperature)

To contain the heat and apply the energy (heat) to the carpet and floor:

1. Set the snout of the E-TES unit under the carpet to create a “soft float”.
2. Pull up one corner of the carpet in the wet area and set the E-TES unit in the corner, on top of the pad. Larger rooms may require additional E-TES units. Leave 3-6 inches between the back of the E-TES box and the wall.
3. Pull the carpet up over the snout and secure the carpet to the E-TES unit with the carpet clamp. Then pull the E-TES back toward the wall to pull the carpet tight. Pulling the carpet tight will eliminate or reduce carpet flapping during the float.
4. Now place the one or two 10 lb sandbags on the carpet, along the wall, on each side of the unit to hold down the carpet and prevent it from pulling off of the tack strip.
5. Cut the pad on each side of the E-TES unit and fold the pad up on top of the carpet. This will help seal the space between the carpet and the floor on each side of the E-TES unit to reduce air escaping. Secure the pad to the carpet with pad pins or use Foam Filler to make a good seal. A good seal will increase the amount of heated air flowing under the carpet and improve the float.



SAND BAG



FOAM FILLER

6. Insert a centrifugal air mover into the E-TES box. Plug the air mover cord into the wall outlet. Connect the two GFCI power cords to the E-TES SD 120 Volt unit and plug the cords into two different 120v circuit outlets.
7. Place remote sensors for air temperature, surface temperature and moisture level as needed in desired locations. Connect the sensors to the E-TES SD120 Volt unit.
8. Turn on the E-TES SD unit and adjust the set points for each of the remote sensors as required for your application.
9. Turn on the air mover.
10. Adjust the speed of the air mover, use additional sand bags to hold the carpet down in some spots and pad pins to lift the carpet in some areas as needed to get the carpet floating and prevent flapping.

PAD PIN

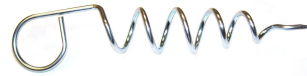

Step #3 - Airflow applied directly to the water
(Evaporation)

1. We are getting air movement with the air mover and the E-TES box is providing the heat. We are heating the water to cause the evaporation, and removing the vapor from the floor by providing airflow under and through the carpet. This heated air heats the carpet, walls, baseboards, sill plates and walls up to 12”, that may also be wet, creating water vapor. As the air escapes through the carpet and along the walls opposite the E-TES unit, it carries the water vapor away from the wet surfaces.

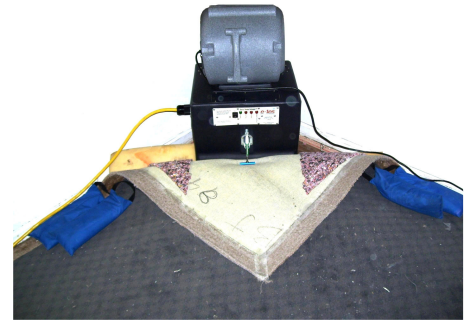

Step #4 - Reduction of vapor saturation levels (humidity) by dehumidification or evacuation (Dehumidification)

As we have evaporated the moisture into the air, we need to remove it from the structure along with the excess heat. This is accomplished with the exhaust controller, an air mover, 14” lay flat duct and a duct ring. Set up the exhaust system to evacuate to the outside of the structure.

Set the Remote Activation temperature to turn on the exhaust fan using the E-TES SD Remote Exhaust Fan Control or use a separate exhaust control unit set for the proper temperatures (see the instructions included with the controller unit). **Overheating the structure may cause damage to structure or contents.**

Controlling the temperature is important to prevent damage. Monitor your progress at least daily – more often if practical. Carpets, floors and walls will dry quickly!



Air mover with ducting connected to Exhaust Controller

Exhaust Controller MB230



Remote Exhaust Fan Control AT206

Wood Floor Drying Procedure

Step #1 – Extraction

1. This is the key for any drying and especially for wood floor drying. Extract the pooled water on top of the wood with your portable or truck mounted equipment. Use a squeegee type wand. A carpet wand may scratch the floor's finish.
2. You can also use a mop or towels. The more you remove this way, the faster it will dry.
3. Now what about the water between or under the boards? Many times there is still a substantial amount of “free” water that can be extracted to speed up the drying. To remove that water, you need to use a floor drying panel system. Place the panels on the floor and attach the hoses in the position the system will be running; however, before you attach your blower unit, attach it to your extraction unit. Let this run for up to 30 minutes or as long as you can. Pull up each panel and, using a towel, wipe up the excess water that will have been drawn out of the floor system. Depending on the amount of water, you may wish to repeat that step. You will be amazed at the amount of extra water you can remove this way.
4. Now reposition your panels and tape them as needed. Attach your blower and start the system.



Step #2 - Energy applied directly to the water (*Temperature*)

1. Set up the wood floor drying panels and attach to the vacuum unit that was designed for this application.
2. Direct containment is the best way to apply the energy (heat) to the floor. Spread poly sheeting (4-6 mil) over the affected floor and cut slightly larger than the area.
3. Now place the 10 lb sandbags around the perimeter every 3 – 4 feet or as needed to hold the poly sheeting down. You may even utilize any furniture in the room along the edges to hold the sheeting.
4. Place the snout of the E-TES (Electric Thermal Exchanger) under the sheeting and secure it with the clamp.
5. Place remote sensors for air temperature, surface temperature and moisture level as needed in desired locations. Connect the sensors to the E-TES SD.
6. Insert a centrifugal air mover into the E-TES SD box. Connect the power cord to the E-TES SD and plug in the E-TES and air mover cords.
7. Turn on the air mover and the E-TES unit.
8. Adjust the set points for each of the remote sensors as required for your application.
9. If you have a crawlspace to place an E-TES or can direct more heated airflow below the floor, it will aid in the drying process.
10. It is important that the blower for the floor drying panel system be placed outside the direct containment (i.e. NOT under the poly sheeting).



Step #3 - Airflow applied directly to the water (Evaporation)

1. We are getting air movement with two pieces of equipment – the air mover / E-TES box and also the floor drying panel system. We are heating the water to cause the evaporation, but the floor drying panel system is removing the vapor from the floor by providing airflow through the interspatial cavities in the floor.
2. The sandbags – rather than stapling/taping/sealing – allows the air to escape bringing with it water vapor and heating the walls, baseboards and sill plates that may also be affected.



Air mover with ducting connected to Exhaust Controller

Step #4 - Reduction of vapor saturation levels (humidity) by dehumidification or evacuation (Dehumidification)

Now that we have evaporated the moisture into the air, we need to remove it from the structure along with the excess heat. This is accomplished with the exhaust controller, an air mover, 14” lay flat duct and a duct ring. Set up the exhaust system to evacuate to the outside of the structure.

Set the Remote Activation temperature to turn on the exhaust fan using the E-TES SD Remote Exhaust Fan Control or use a separate exhaust control unit set for the proper temperatures (see the instructions included with the controller unit). **Overheating the structure may cause damage to structure or contents. Controlling the temperature is important to prevent damage.**

Since there is less water in the wood than would be in a carpet/pad combination, the exhaust doesn't need to cycle as often. Monitor your progress at least daily – more often if practical.

Floors will dry quickly!

Smart E-TES Remote Exhaust Controller AT206



Exhaust Controller MB230



Wall Drying Procedure

Step #1 – Access Wall Cavity

1. Remove the base board from the wall. Remove the base board carefully, including cutting any caulk bead at the top to prevent damage to the drywall. If not damaged, the base board can be re-installed after the drying process is completed.
2. Locate the wall studs in the area to be dried.
3. Drill 1” diameter access holes through the wall. Locate the holes between the studs, just above the wall base plate. Whenever possible place holes where they will be covered by the base board after drying is completed.
4. Insert one Octi-Dry outlet tube into each hole. Turn tube to point air flow in the desired direction. Multiple Octi-Dry units can be connected together for larger areas.

Step #2 - Energy applied directly to the water (Temperature)

1. Insert the snout of the E-TES unit into the large opening of the Octi-Dry. Secure the Octi-Dry to the E-TES snout with the Velcro strap and the carpet clamp. Seal the ends of the Octi-Dry to prevent air leaking. When using multiple Octi-Dry units connected together, seal the Velcro strips on the other large openings to prevent air from leaking out.
2. Insert a centrifugal air mover into the E-TES box. Plug the air mover cord into a wall outlet. Connect the two GFCI power cords to the E-TES SD 120volt unit and plug the cords into two different 120v circuit outlets.
3. Place remote sensors for air temperature, surface temperature and moisture level as needed in desired locations. Connect the sensors to the E-TES SD.
4. Turn on the E-TES SD unit and adjust the set points for each of the remote sensors as required for your application.
5. Turn on the air mover.
6. In some cases the Octi-Dry may restrict the E-TES outlet air flow enough to prevent the E-TES airflow switch from engaging. The Airflow Light will remain off and the heater will not get hot. If the air mover is running and the Airflow Light is off, open one end of the Octi-Dry to increase the total airflow. Open the end a small amount at a time until Airflow light comes on. Only open the end as much as needed to engage the airflow switch. Opening the end too much may reduce the flow through the outlet tubes and increase the drying time.



Octi-Dry Secured to E-TES Snout



End opened for increased airflow

Step #3 - Airflow applied directly to the water (Evaporation)

1. We are getting air movement into the wall with the air mover / E-TES box and the Octi-Dry system. We are heating the water to cause the evaporation, but the water vapor still needs to be removed from the wall.
2. If the wall is wet top to bottom, air outlet holes *may* need to be drilled at the top of the wall between the studs to allow the water vapor to be removed from the wall cavity. If the wall is only wet at the bottom, drill an outlet hole below the baseboard level to allow moist air to escape.



Step #4 - Reduction of vapor saturation levels (*humidity*) by dehumidification or evacuation (*Dehumidification*)

Now that we have evaporated the moisture into the air, we need to remove it from the structure along with the excess heat. This is accomplished with the exhaust controller, an air mover, 14" lay flat duct and a duct ring. Set up the exhaust system to evacuate to the outside of the structure.

Set the Remote Activation temperature to turn on the exhaust fan using the Smart E-TES Remote Exhaust Fan Control or use a separate exhaust control unit set for the proper temperatures (see the instructions included with the controller unit). **Overheating the structure may cause damage to structure or contents.**

Controlling the temperature is important to prevent damage.

Monitor your progress at least daily – more often if practical. Walls will dry quickly!



**Exhaust Controller
MB230**



**Air mover with ducting
connected to Exhaust
Controller**



**Air Temperature Sensor
AT202**



**Surface Temperature
Sensor AT200**

**Smart E-TES Remote
Exhaust Fan Control
AT206**



**Moisture Sensor
PGE5060**



Heater Operation Procedure

Knowledge of the proper operation of the heater and heat exchange system is required for safe operation and to keep heater and components operating properly.

- 1) Read and understand the Remote Probe connection procedures and Menu Navigation in **SECTION #2** before proceeding with set-up and operation.
- 2) Place the E-TES SD unit as required for your drying situation. **(SEE SET-UP SECTION #2)**
- 3) Connect Remote Sensors as needed, place Remote Sensors in desired locations.
- 4) Connect the two GFCI E-TES power cords to two different 120volt outlets. If you have a 20amp circuit one air mover should be able to be plugged into the same circuit as one GFCI E-TES SD power cord. Check the circuit breakers and the amp draw of your air mover to determine if the circuit can handle the load. If you are unsure, plug the air movers into an outlet on a third circuit.
- 5) Make sure E-TES SD unit power switch is in the OFF position, and then connect the receptacle end of the GFCI cords to E-TES SD unit. Reset GFCI on both power cords. Push TEST button to test GFCI and if RESET button pops out, push RESET button back in and proceed with set-up. If RESET button does not pop out when TEST button is pushed, replace cord or contact your nearest service center for advice or assistance.
- 6) Turn E-TES SD unit power switch to the ON position. Observe Dual Circuit indicator light next to rocker switch. If green light is ON, cords are on separate circuits and you can proceed with set-up. If light is OFF both cords are on the same circuit and one cord must be moved. When cords are on separate circuits and green Dual Circuit indicator light is on proceed with set-up.

If Cord #1 is connected properly and supplying power to the Cord #1 connector, the LED display, POWER light and HEATING light will operate normally even if Cord #2 is disconnected or connected to a dead outlet. The unit will still operate, but at only one half of its rated heat output.

- 7) Set the Remote Sensor activation points at the temperature or moisture level required for your application. **(See SECTION 2 for Instruction on how to set activation points.)**
- 8) Place an air mover into the E-TES SD unit. Plug in the air mover and turn the air mover switch ON.

- 9) Observe indicator lights. When both green lights are illuminated system is operating properly and the heating elements are getting power. If the green **HEATING** light is off, the unit is not heating properly.
- **POWER** – When the green **POWER** light is lighted it indicates that the heater switch is in the ON position and the power has been supplied to the heater. (If the green **POWER** light is OFF the other lights will not light.)
 - **HEATING** – When the second green light, the **HEATING** light, is lighted it indicates that power is being supplied to the heating elements and the unit should be heating. If cord #2 is unplugged the heating light can still turn ON. To assure proper heating, make sure the Dual Circuit indicator light is ON.
 - **AIR FLOW** – When the first red light, the **AIR FLOW** light, is lighted it indicates that there is not sufficient air flow for the heater to operate or the airflow switch is malfunctioning and power is being shutoff to the heating elements. When the **AIR FLOW** light is ON, the **HEATING** light should be OFF.
 - **OVERTEMP** – When the second red light, the **OVERTEMP** light, is lighted it indicates that the heating element temperature is above the safe operating range and power being shutoff to the heating elements. When the **OVERTEMP** light is ON, the **HEATING** light should be OFF.

If the green **HEATING** light is not lighted look for the following:

- If the two red lights are OFF, but the **HEATING** light does not come on, make sure you have power to E-TES SD and the green **POWER** light is ON. Check your set points on your remote sensors. One or more of them may be reading beyond their set point and have shut off the power to the heating elements. Usually when this happens the display screen will flash indicating the sensor which has signaled the unit to shutdown. Reset your activation points, disconnect or replace the sensors as needed.
 - If the green **HEATING** light is OFF and the red **AIR FLOW** light is ON, the air flow through the E-TES SD unit is not enough to allow the Air Flow switch to be engaged. Check the air mover operation and check the circuit providing power to the air mover to assure proper air flow. If the air mover is operating properly, the discharge flow may be restricted. If you are using an Octi-Dry, open one end of the Octi-Dry or remove restriction. Open it only as much as needed to engage the air flow switch. If the **AIR FLOW** light does not turn off, there could be a loose wire or the airflow switch may be defective. Contact your nearest service center for advice or assistance.
 - If the green **HEATING** light is OFF and last red light, the **OVERTEMP** light is ON the heating elements may have reached the maximum temperature or the internal temperature of the E-TES SD box is too high and the power to the heating elements has been cut-off to allow the unit to cool. Turn the heater switch OFF. Make sure the air mover is ON and remove any restriction to allow the air flow to cool the elements. When cool turn the heater switch back ON. If the unit has cooled and the **OVERTEMP** light stays on, there could be a loose wire or the temperature switches could be defective. Contact your nearest service center for advice or assistance.
- 10) Observe unit operation to be sure that air flow is kept at a high enough flow rate to prevent the heater from turning ON and OFF. Remove restrictions to increase air flow as needed to maintain proper air flow rate.
- 11) Make sure circuit breakers are not tripping and the power supply to the air mover and E-TES SD unit will not be interrupted.
- 12) When the E-TES SD unit is adjusted properly and operating normally, the unit can be left alone during operation.

HEATER SHUTDOWN PROCEDURE

- 1) Turn the heater switch to the OFF position.
- 2) Keep the air mover running for 5 minutes to cool the heating elements.
- 3) When the unit has cooled turn the air mover OFF.
- 4) If required, insert USB Flash Drive into the USB port on the E-TES front panel, turn switch ON to log data from job. When Flash Drive stops flashing, turn switch off, remove the Flash Drive and proceed with shutdown. (Display will freeze on **Updating USB - Do Not Remove** screen while data is downloading.)

Purchase & installation of optional Activation Key & E-TES Charter software required to retrieve data log information from the E-TES SD.

- 5) Disconnect the power cords from the power outlets and heater connections. Roll up and store cords.
- 6) Remove and store air movers and E-TES SD Electric Thermal Exchanger.

E-TES SD Troubleshooting

Problem	Cause	Solution
Circuit Breaker	Both cords on one circuit	Move one cord to a separate circuit
Blowing	Too much current demand on circuit	Move plug to another outlet & circuit or disconnect other devices from this circuit.
	Circuit breaker faulty	Move plug to another outlet & circuit or have electrician replace circuit breaker
	Heating Element faulty	Replace Heating Element
	Faulty power cord	Replace cord NM4407
	Faulty switches or internal wiring	Check wiring & test switches - Repair as needed *
Unit Not Heating	Heater Switch in OFF position	Turn switch to ON position
HEATING Light OFF (GREEN)	Building circuit breaker tripped.	Reset breakers or move cords to other outlets
	GFCI tripped	Reset GFCI
	Faulty power cord	Replace cord
	Faulty GFCI	Replace cord (NM4407) or replace GFCI (PT080)
	Air Mover not running	Turn on air mover or check power to air mover. Repair or replace air mover as needed
	Low Air Flow	Remove restrictions to maintain adequate air flow
	Probe Temperature set too low	Reset Air Temp & Surface Temp set points
	Moisture 1 or 2 set point too low	Reset Moisture Value set points
	Moisture 1 or 2 Value stuck at zero	With probe connected, turn Power switch OFF then ON
	Faulty Remote probes	Check probe readings – Replace probes as needed
	Internal Temperature sensor faulty	Replace circuit board
	Faulty switches or internal wiring	Check wiring & test switches - Repair as needed *
	Faulty Safety Switch	Observe Lights to determine function Correct condition or Repair as needed *
	Faulty indicator light	Replace light
POWER Light OFF (GREEN)	Heater Switch in OFF position	Turn switch to ON position
	Building circuit breaker tripped.	Reset breakers or move cords to other outlets
	GFCI tripped	Reset GFCI
	Faulty power cord	Replace cord
	Faulty GFCI	Replace cord (NM4407) or GFCI (PT080)
	Faulty switches or internal wiring	Check wiring & test switches - Repair as needed *
Start-Up Error Display	Memory Locked Up	Re-initialize Memory (See page 35)
	Software Corrupted	Reprogram processor (See page 17)
	Circuit Board Faulty	Replace circuit board

* To reduce the risk of injury, repairs to electrical systems should only be performed by experienced technicians. Contact your nearest service center for assistance.

E-TES SD Troubleshooting Continued

Problem	Cause	Solution
Air Flow Light ON (RED)	Air Mover not running	Turn on air mover or check power to air mover. Repair or replace air mover as needed
	Low Air Flow	Remove restrictions to maintain adequate air flow
	Unit Overheated	Let unit cool. Reset Hi-Limit Switch as needed.
	Faulty switches or internal wiring	Check wiring & test switches - Repair as needed *
	Air Switch out of calibration range	Recalibrate Air Flow Switch (See page 10)
	Faulty Safety Switch	Observe Lights to determine function Correct condition or Repair as needed *
OVERTEMP Light ON (RED)	Unit Overheated	Let unit cool. Allow temperature Switch to cool off and reset.
	Faulty switches or internal wiring	Check wiring & test switches - Repair as needed *
	Faulty Temperature Switch	Observe Lights to determine function Correct condition or Repair as needed *
Remote Sensors Not reading	Faulty sensor	Replace sensor
	Circuit board faulty	Replace circuit board
	Software Corrupted	Reprogram processor (See page 17)
Display Blank	No Power	Check green power light – See green light section
	Faulty switches or internal wiring	Check wiring & test switches - Repair as needed *
	Faulty indicator Display	Replace Circuit Board
	Processor Locked Up	Reset Processor (See page 37)
	Software Corrupted	Reprogram processor (See page 17)
Clock, Date or Time Wrong	Temporary Glitch	Reset Date & Time (See page 10)
	Software Corrupted	Reprogram processor
	Battery Dead	Replace Battery – Use Panasonic BR-2/3A only
	Circuit Board Faulty	Replace Circuit Board
Cannot move through menu	Wrong key being pushed	Check instructions for available key options for each screen
	Process locked up	Turn power switch OFF and back ON to reset
	Faulty push buttons	Replace circuit board
	Faulty circuit board	Replace circuit board
	Software corrupted	Reprogram processor (See page 17)
System Overheating	Faulty switches or internal wiring	Check wiring & test switches - Repair as needed *
	Faulty Safety Switch	Observe Lights to determine function Correct condition or Repair as needed *
	Not enough Heat draw from system Air Flow too low	Turn air movers switches to higher speed or remove restrictions to increase air flow
	Room Temperature too high	Use exhaust controllers to reduce room temperature
	Internal Temperature sensor faulty	Replace circuit board
	Remote temp sensor set point too high	Reset air & surface temperature set points
	Defective remote sensors	Replace air temperature or surface temperature remote sensors

E-TES SD 120 VOLT INDICATOR LIGHT PANEL CONFIGURATIONS

E-TES SD INDICATOR LIGHTS:

During normal operation both Green lights will be ON when the unit is heating.

POWER LIGHT

When the green POWER light is ON, the switch is on and power is being supplied to the unit.

HEATING LIGHT

When the green HEATING light is ON, the controls are all within limits and power is being supplied to the heating elements



AIR FLOW LIGHT & OVERTEMP LIGHT

If either red light is ON, the green HEATING light will turn off, indicating that the unit is no longer heating.

If Cord #1 has power the POWER light and the green HEATING light can still turn ON, even if Cord #2 is disconnected. Make sure both cords are connected and DUAL CIRCUIT INDICATOR light is ON for proper heater operation.

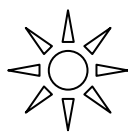

Indicates Light is ON



Indicates Light is OFF

When both of the green lights are ON and both red lights are OFF, as shown here, the heater is operating normally and the heating elements are receiving power. Dual Circuit Indicator light must also be ON for proper heater operation.

POWER

HEATING

AIR FLOW

OVERTEMP



When the red **AIR FLOW** light is ON, the air flow is too low for proper operation and the unit has shutoff the power to the heating elements. This will cause the green **HEATING** light to turn OFF.

If the air flow is restored, the red **AIR FLOW** light will turn off, the green **HEATING** light will turn back on and the unit will again heat up.

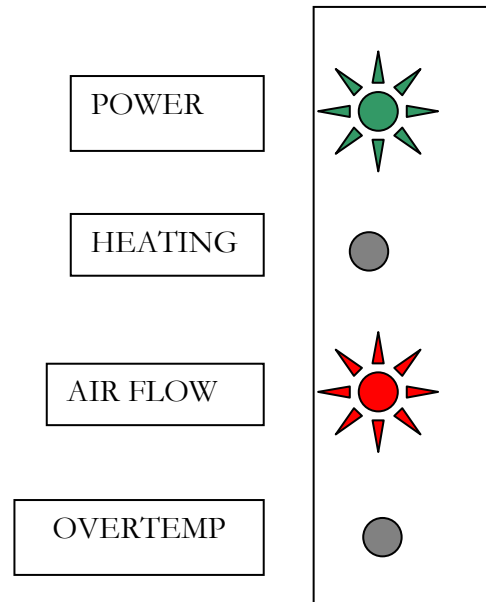

When the red **OVERTEMP** light is ON, the temperature of the heating elements has exceeded 250°F and the unit has shutoff the power to the heating elements. This will cause the green **HEATING** light to turn OFF.

The red **OVERTEMP** light will also come on if the internal temperature exceeds 150° and the internal temperature switch on the circuit board shuts off the power to the heating elements.

When the temperature cools sufficiently the red **OVERTEMP** light will turn off, the green **HEATING** light will turn back on and the unit will again heat up.

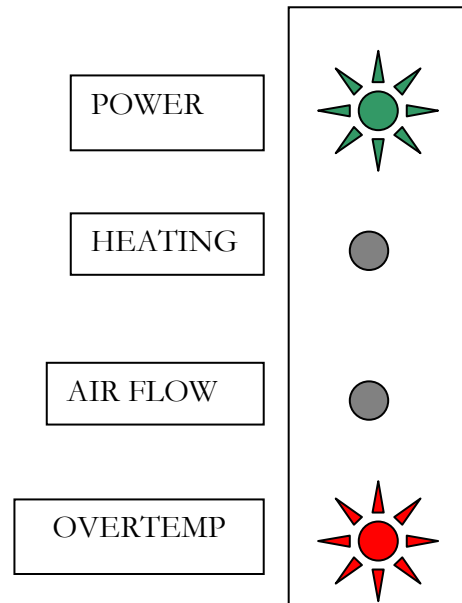

In some situations when the air flow is too low and the **AIRFLOW** light comes ON, the heat exchangers will also over heat and cause the **OVERTEMP** light to come ON too.

When the air flow is restored the red **AIR FLOW** light will turn OFF and when the temperature cools sufficiently the red **OVERTEMP** light will turn OFF, the green **HEATING** light will turn back ON and the unit will again heat up.

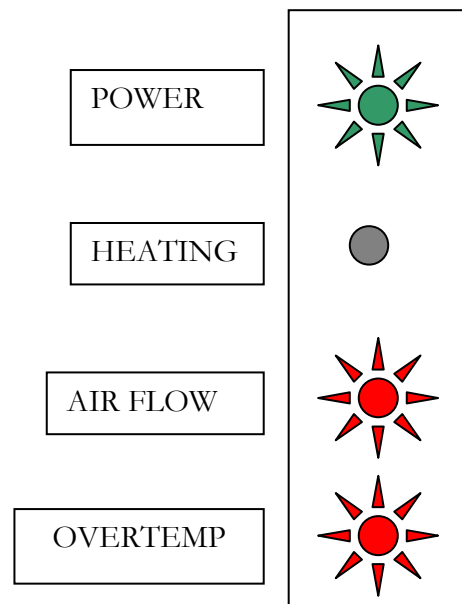

When the green **HEATING** light is OFF, but neither of the red lights is ON, it usually means that one on the remote sensors is getting a reading past its set point. When the AIR TEMPERATURE, SURFACE TEMPERATURE or MOISTURE VALUE measured by the corresponding probe exceeds the set point the green **HEATING** light will turn OFF indicating unit has shutoff the power to the heating elements.

The screen for the sensor sending the shutdown reading will be displayed, flashing the current reading and the shutoff set point.

When the temperature cools sufficiently or the moisture level rises the green **HEATING** light will turn back ON and the unit will again heat up.

POWER

HEATING

AIR FLOW

OVERTEMP



The power supply to the E-TES SD unit has been cut off. Check the building circuit breakers and the GFCI cords and reset as needed. There also could be a malfunction in the heater switch or other internal wiring. Contact your nearest service center for assistance.

POWER

HEATING

AIR FLOW

OVERTEMP



ALL OTHER LIGHT COMBINATIONS WILL ONLY OCCUR WHEN THERE IS A MALFUNCTION IN THE SYSTEM. IF YOU HAVE A LIGHT COMBINATION NOT SHOWN AND DESCRIBED HERE, CONTACT YOUR NEAREST SERVICE CENTER FOR ADVICE OR ASSISTANCE.

E-TES SD 120 Re-initializing the Memory

On occasion the memory on the E-TES SD units will need to be re-initialized. When this happens, the E-TES SD will not function and the display will show the **Start-up Error** screen when the power switch is turned on or will not accept new software updates. These problems can usually be corrected in the field by re-initializing the E-TES SD memory.

1. Connect the power cord to the power source and reset the GFCI.
2. Connect the power cord to the E-TES SD. For 120volt units only cord #1 will need to be connected.

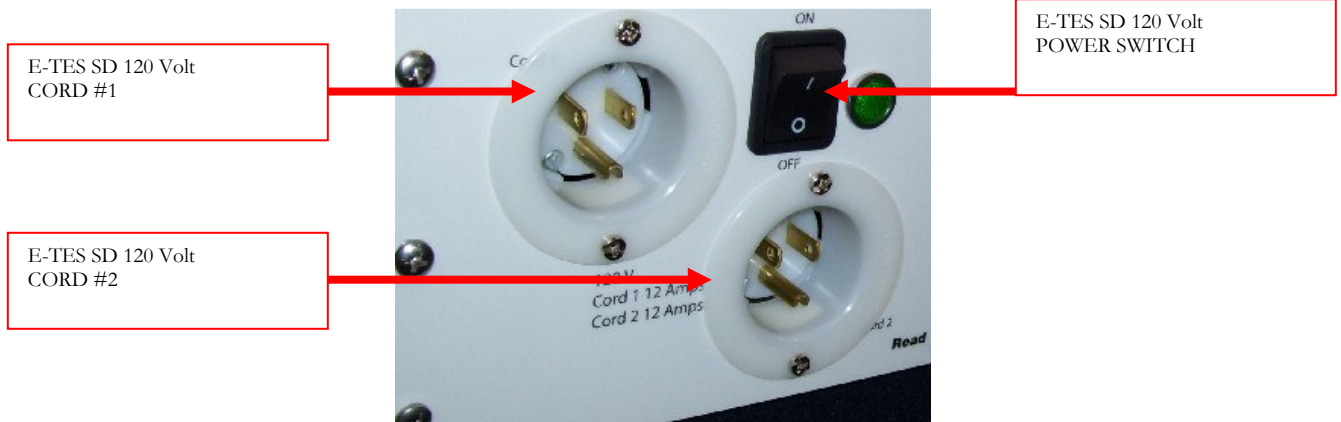

3. If you are updating the software, insert the flash drive with the new software into the USB port on the front panel of the E-TES SD.

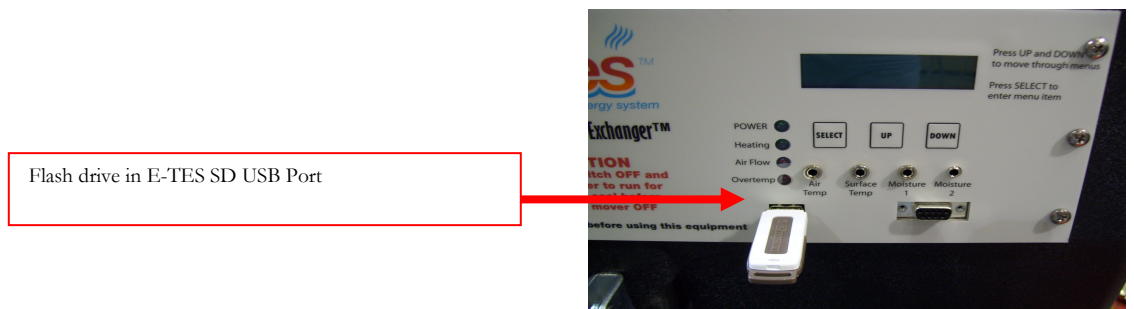

4. Press and hold both the UP button and DOWN button while your turn the power switch ON.



E-TES SD USB PORT

Hold both the UP button and DOWN button while you turn the power switch ON.

5. Continue to hold both the UP button and DOWN button until the advances past the booting screen. If you are updating the software you can release the buttons as soon as you see the Update Screen. Once the memory is re-initialized and the software is updated the unit should advance to the main screen and operate normally. If not, contact you E-TES SD distributor for advice or assistance.



E-TES SD
Booting Screen

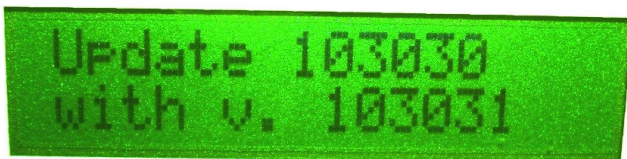

E-TES SD
Software Update Screen



E-TES SD
Update Completed Screen



E-TES SD
Main Screen

E-TES SD 120 Resetting the Processor

On occasion the processor on the E-TES SD units will lock up. When this happens, the E-TES SD will not function and the display will show only a line of rectangles or will remain blank when the power switch is turned on. This problem can easily be corrected in the field by resetting the processor.

E-TES SD machines have a small hole in the front face plate just above the USB port and below the indicator light. With the E-TES SD unplugged and the Power Switch in the OFF position, poke a toothpick or paper clip through the small hole to push the reset button behind the front faceplate. Hold the button for 2-3 seconds.

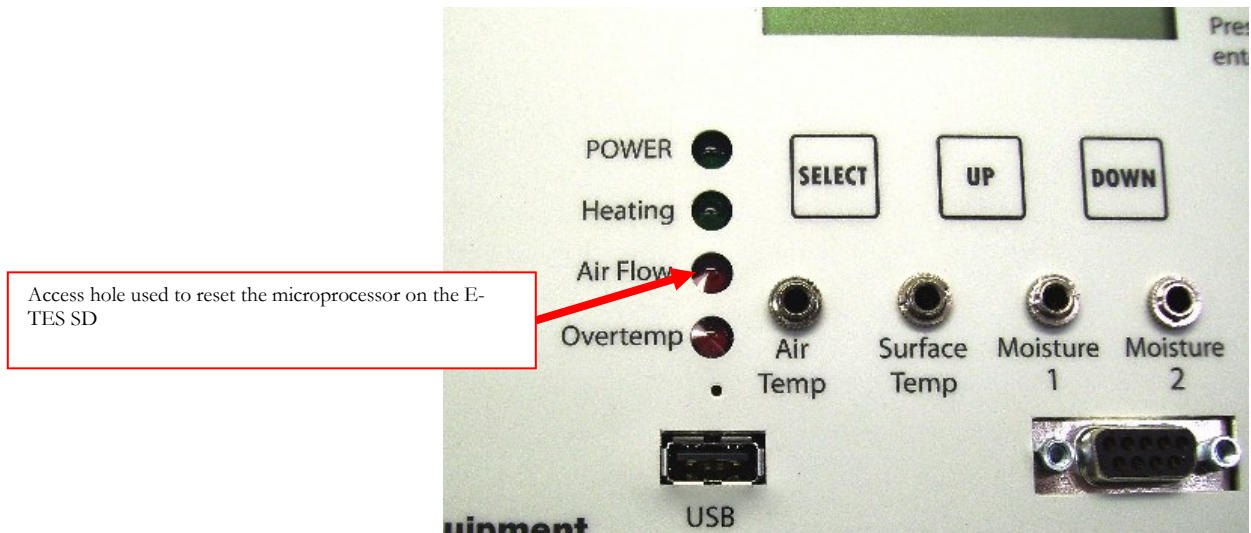

After resetting the processor, the E-TES SD Date & Time Clock must be reset.

Use the UP & DOWN buttons to move through the menu to the current date & time screen.

- ◆ Press **SELECT** to set the E-TES SD Date & Time Clock.
- ◆ HOUR will flash first. Use the **UP/DOWN** buttons to change the HOUR setting. When correct, press **SELECT** to move to MINUTES.
- ◆ Use the **UP/DOWN** buttons to change the MINUTES setting. When correct, press **SELECT** to move to SECONDS & press **SELECT** again to move to the MONTH setting.
- ◆ Use the **UP/DOWN** buttons to change the MONTH setting. When correct, press **SELECT** to move to DAY NUMBER. (The DAY NAME will change as you adjust the MONTH, DAY NUMBER & YEAR.)
- ◆ Use the **UP/DOWN** buttons to change the DAY NUMBER setting. When correct, press **SELECT** to move to YEAR.

Use the **UP/DOWN** buttons to change the YEAR setting. When correct, press **SELECT** to save setting and exit the date & time screen. Use the **UP/DOWN** buttons to move through the menu to check and reset your activation or shutdown settings on Air Temperature, Surface Temperature, Moisture 1, Moisture 2, Remote Setup & Air Flow Setup as needed.

Heater Wiring

Section 4

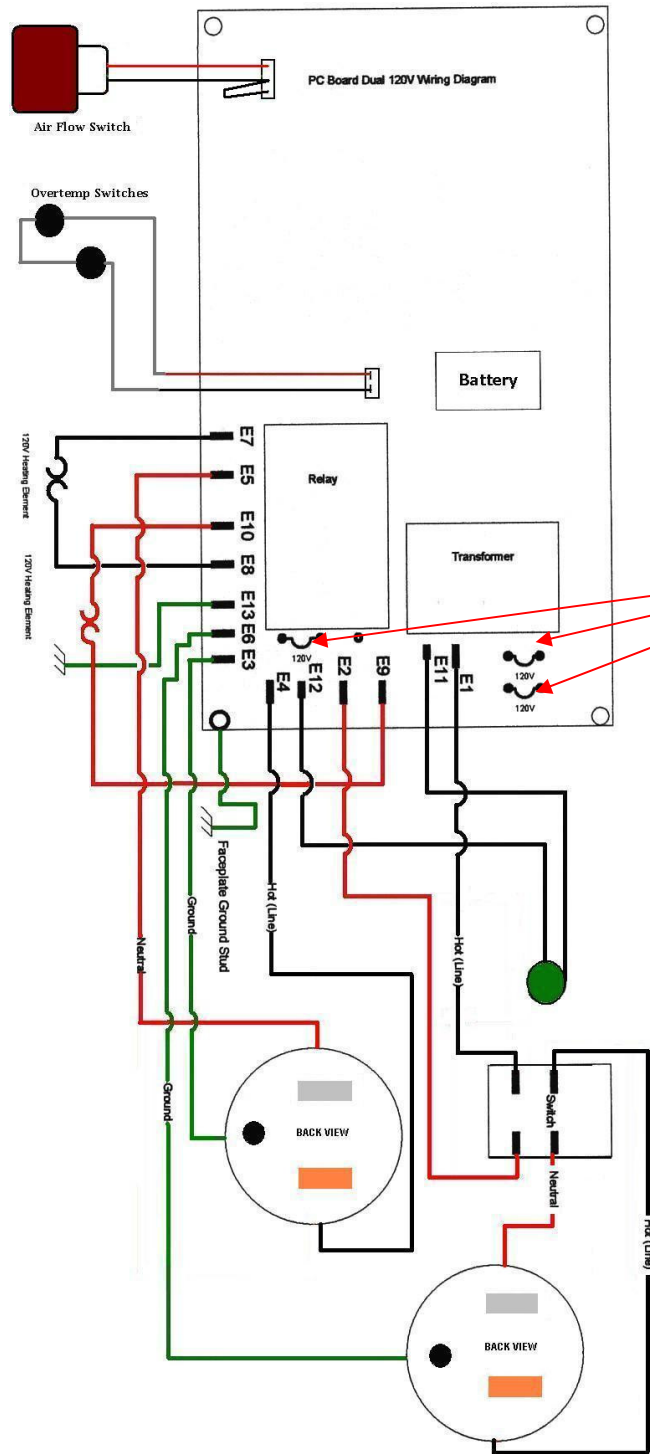

Three jumpers used to convert circuit board for use with 120vac must be in the positions shown for proper operation of E-TES SD unit.

Circuit board may be damaged if board is used with jumpers in the wrong position



Caution: The battery used in this device may present a fire or chemical burn hazard if mistreated. Do not recharge, disassemble, heat above 100° C (212° F) or incinerate. Replace battery with Panasonic, Part Number BR-2/3A only, use of another battery may present a risk of fire or explosion.

Dispose of used battery promptly. Keep away from children. Do not disassemble and do not dispose of in fire.

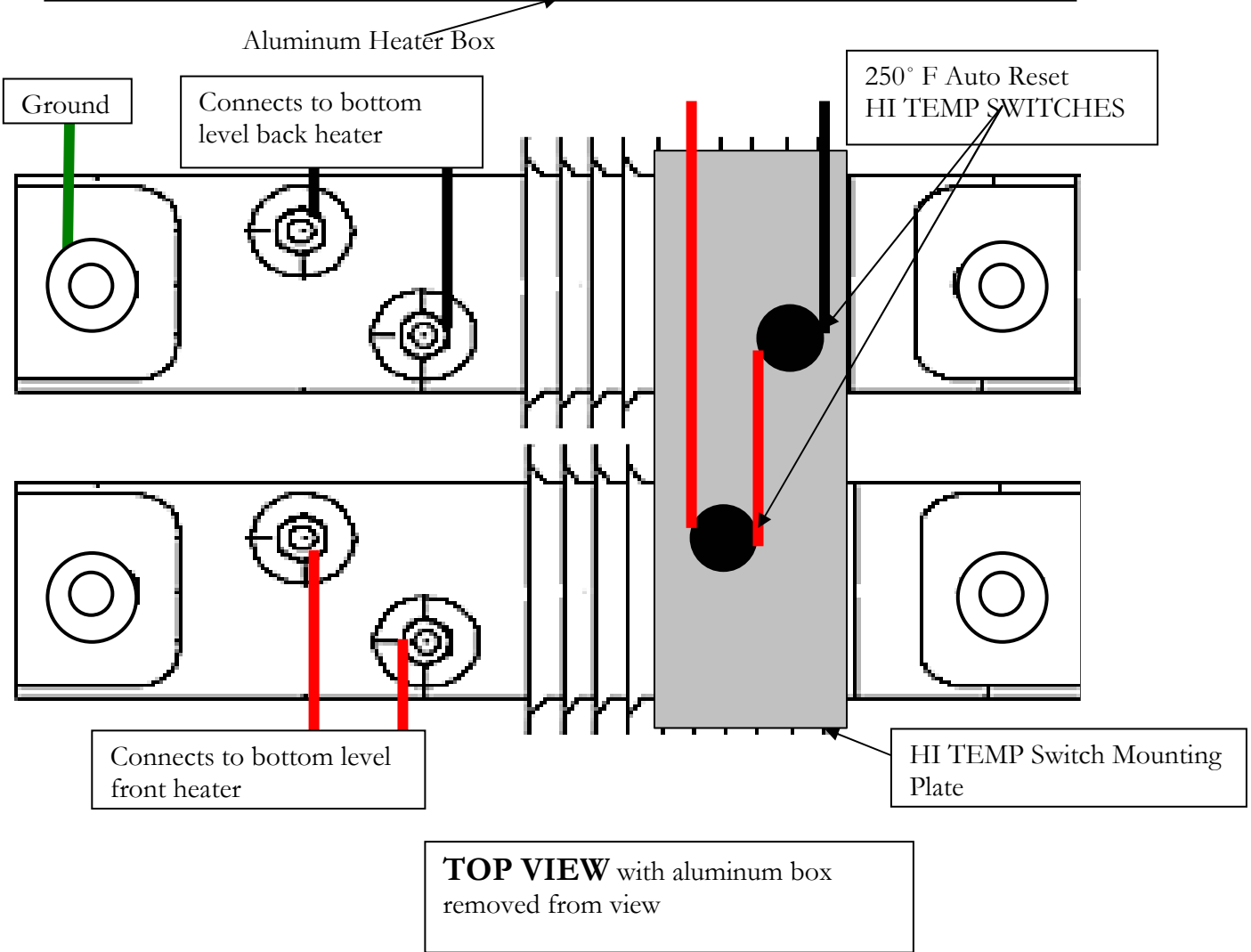
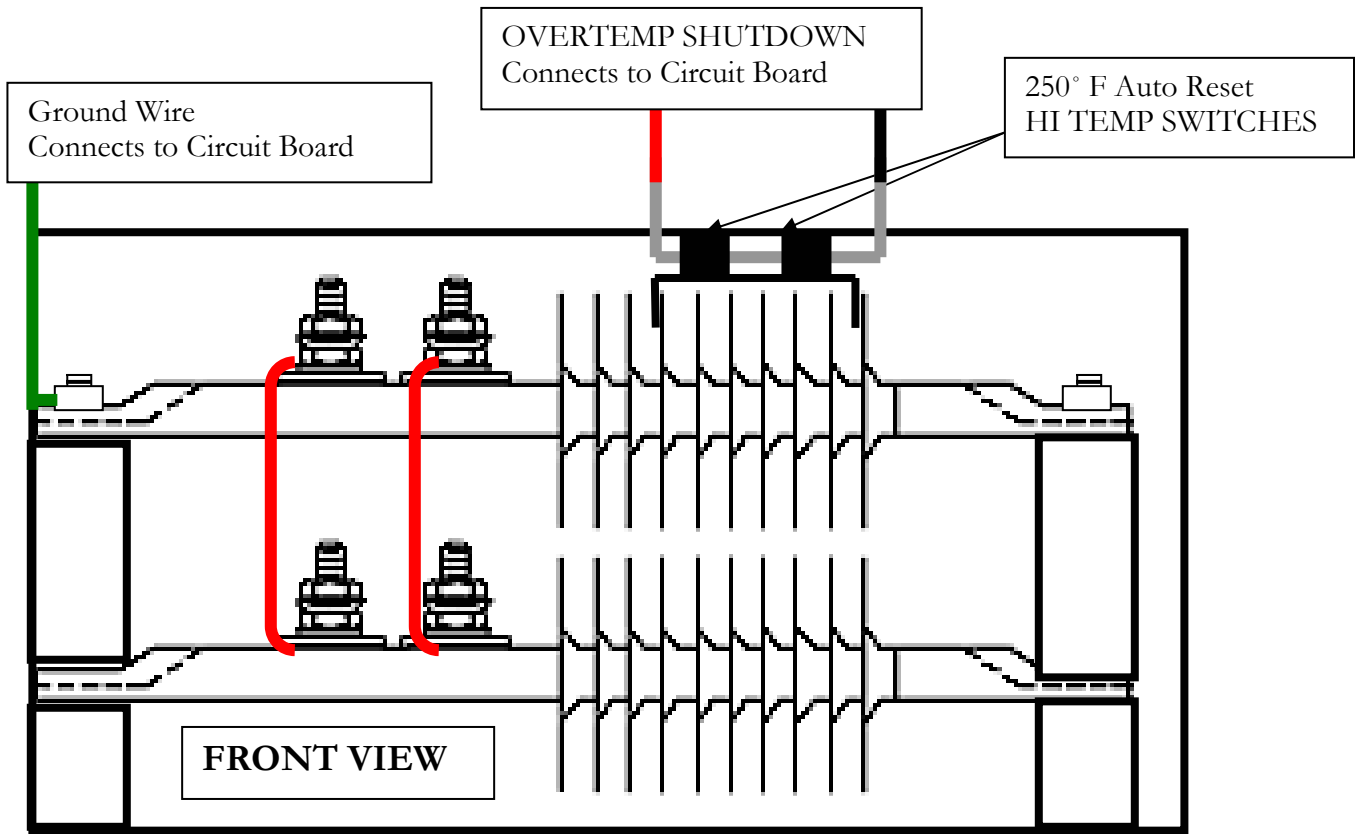

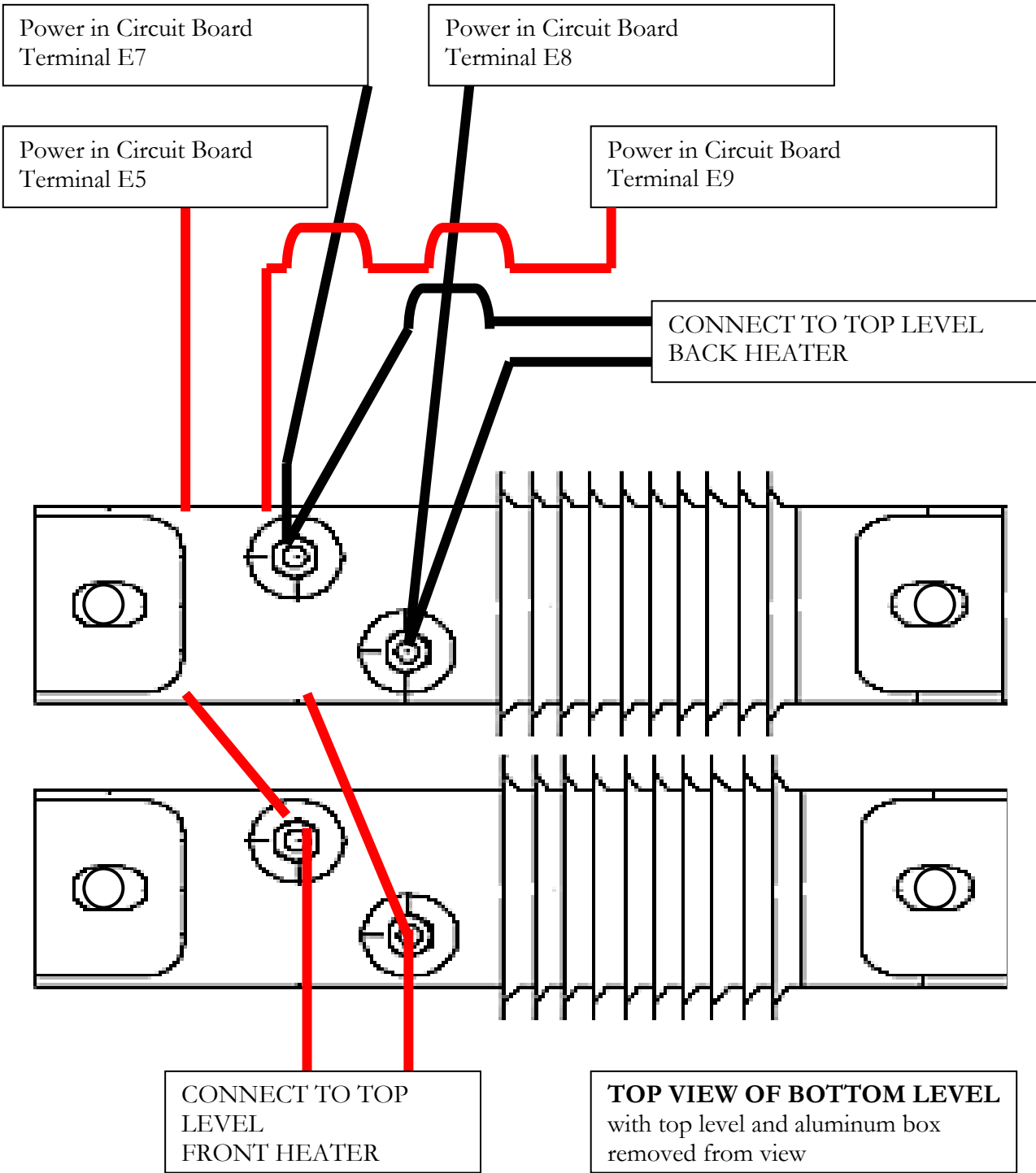

Heater Maintenance

The E-TES SD 120 Volt Electric Thermal Exchanger requires very little maintenance. To perform the following inspections each time before using this equipment:

- Remove lint or debris that may be collecting on heating elements or inside E-TES SD 120 Volt unit.
- Examine wiring to ensure wiring to switches and heating elements is not damaged or worn. Check wire connections to ensure that they are tight and have not worked loose due to vibration or other related conditions.
- Examine plastic E-TES SD 120 Volt unit body for damage and repair or replace as needed.
- Check power cords for wear or damage and repair or replace as needed.
- Clean sensor cord plug ends. Check sensor cords for wear or damage and repair or replace as needed.
- Test GFCI and replace cord if GFCI is not operating properly. Replace cord as needed.

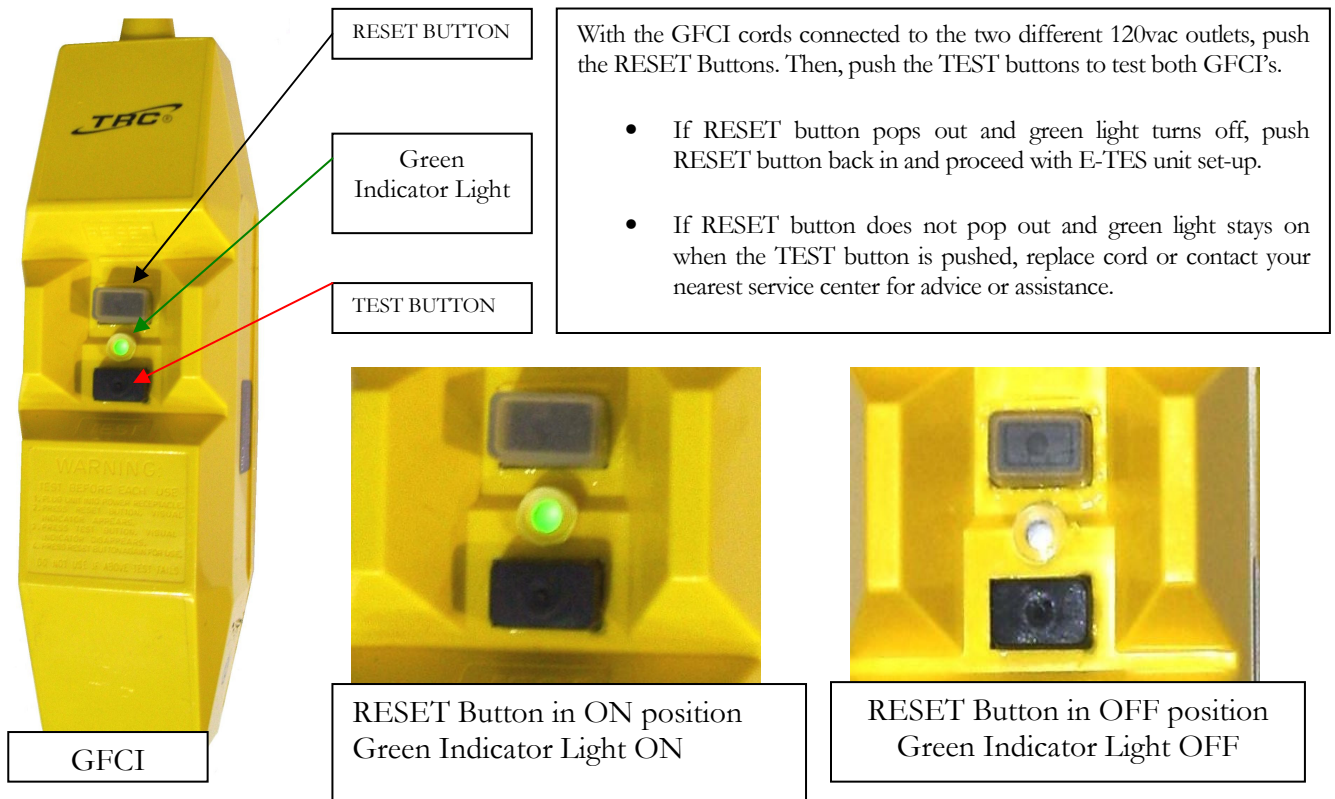

Section
5

Parts

*Replacement parts available for repair of your E-TES SD 120 VOLT
ELECTRIC THERMAL EXCHANGER.*

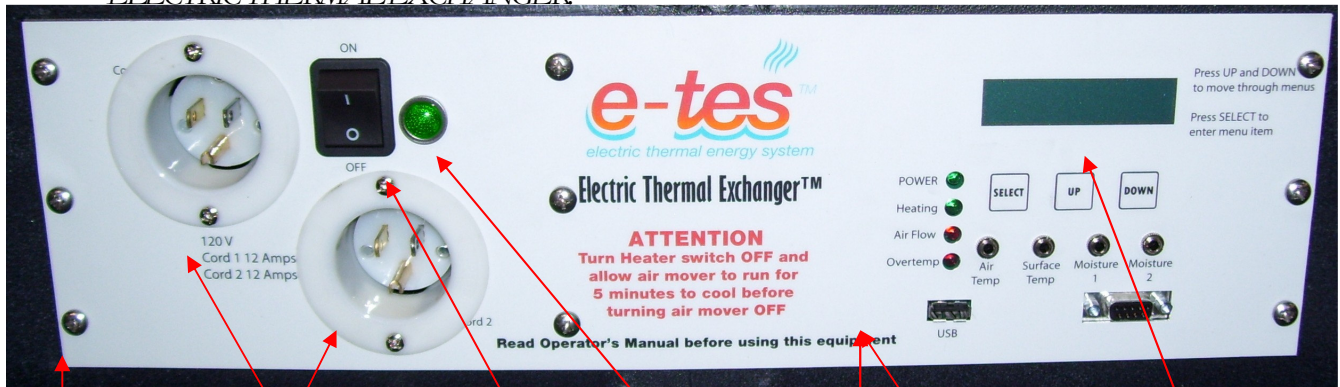

6 & 6a

1

2

3

4

5

7

8

**FRONT SWITCH PLATE
AND 120VAC PLUGS**

1	FLANGED PLUG NEMA 5-15P (QTY 2)	NM4399	7	BODY TEX THERMAL EXCHANGER - PLASTIC	NM4250
2	ROCKER SWITCH DPST	NM5008	8	CIRCUIT BOARD E-TES XD 120V	NM5394A
3	GREEN LIGHT 120V	NM4447	NS	USB PORT DUST CAP	NM5384
4	DECAL SMART E-TES 120 CONTROL PANEL	NM5392	NS	SERIAL PORT DUST CAP	NM5385
5	PANEL SMART E-TES 120 CONTROL	NM5390	NS	BACK COVER CONTROL PANEL	NM5395
6	SCREW 10-24 X 3/4" PPH SS (QTY 9)	NM4244	NS	NUT 6-32 SS NYLOCK HEX (QTY 4)	NM4031
6A	NUT 10-24 NYLOCK SS (QTY 9)	PHY094-034	NS	SCREW 6-32 X .375" PPH SCREW (QTY 4)	NM5436
			NS	WASHER #6 INTERNAL STAR (QTY 4)	NM5434

ELECTRIC TEX BODY AND EXTERIOR COMPONENTS

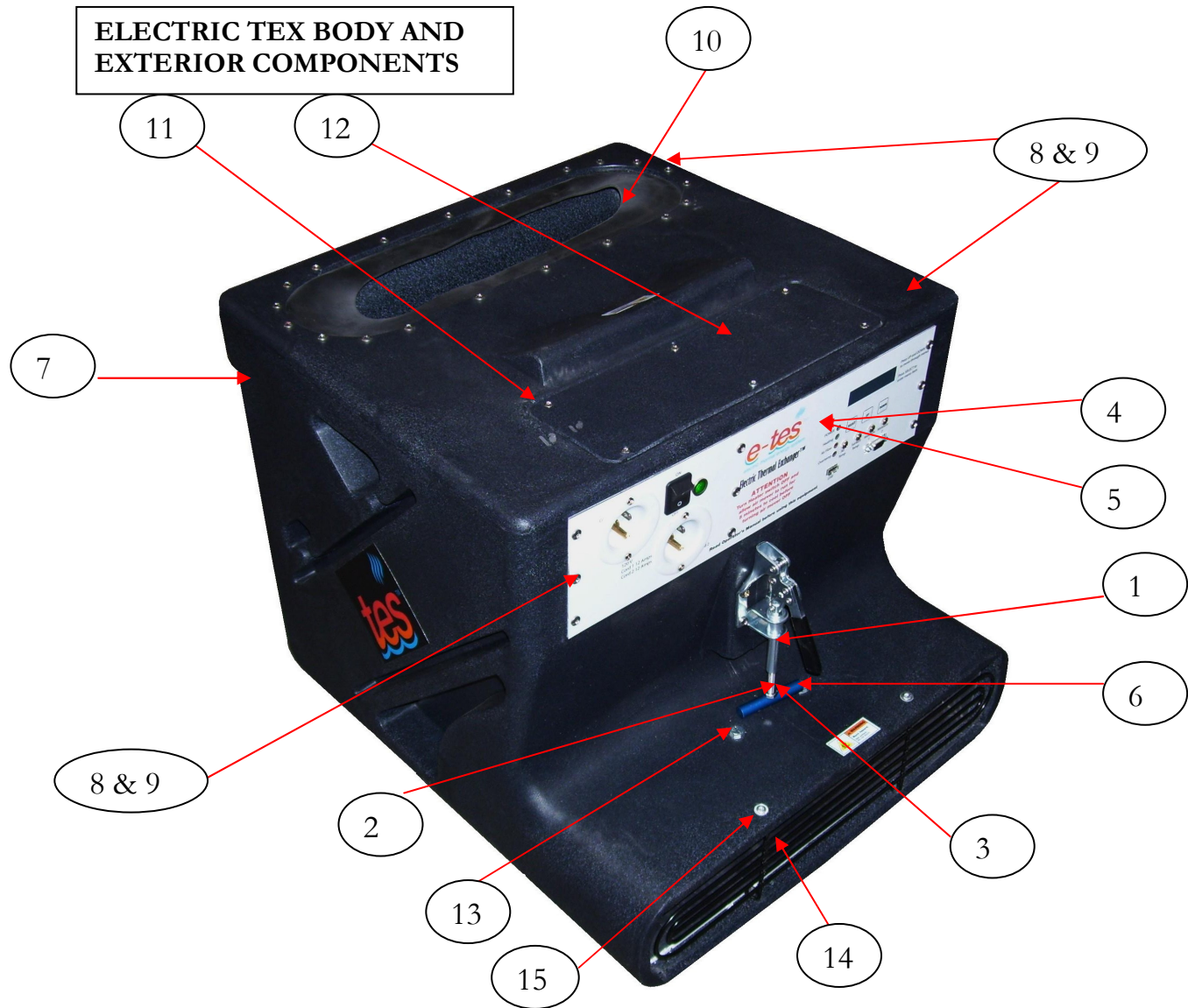

1	TOGGLE CLAMP	NM4245	11	SCREW 8-32 X 3/8" PH SS (QTY 6)	
2	STUD 5/16-18 X 2.5" SS	NM4246	12	COVER PLATE - TEX	
3	NUT 5/16-18 HEX SS	NM4290	13	SCREW 1/4-20 X 1" HX HD (QTY 2)	NM5034
4	DECAL SMART E-TES 120 CONTROL PANEL	NM5392	14	FRONT GRILLE	NM4430
5	PANEL SMART E-TES 120 CONTROL	NM5390	15	RIVET 1/8" X 3/4" ALUMINUM (QTY 4)	NM5025
6	BAR 1/2" X 3" CARPET CLAMP	NM4247	NS	NUT 1/4-20 HEX NYLOCK	NM4261
7	BODY TEX THERMAL EXCHANGER (Includes #11, #12)	NM4250	NS	ALUMINUM HEATER BOX LARGE - SMART E-TES	NM4415
8	SCREW 10-24 X 3/4" PPH SS	NM4244	NS	INSIDE GRILLE	NM4432
9	NUT 10-24 NYLOCK SS	PHY094-034	NS	BACK COVER CONTROL PANEL	NM5395
10	GASKET SILICONE RUBBER	NM4238	NS	RETAINER PLATE - GASKET	NM4241

CARPET CLAMP ASSEMBLY

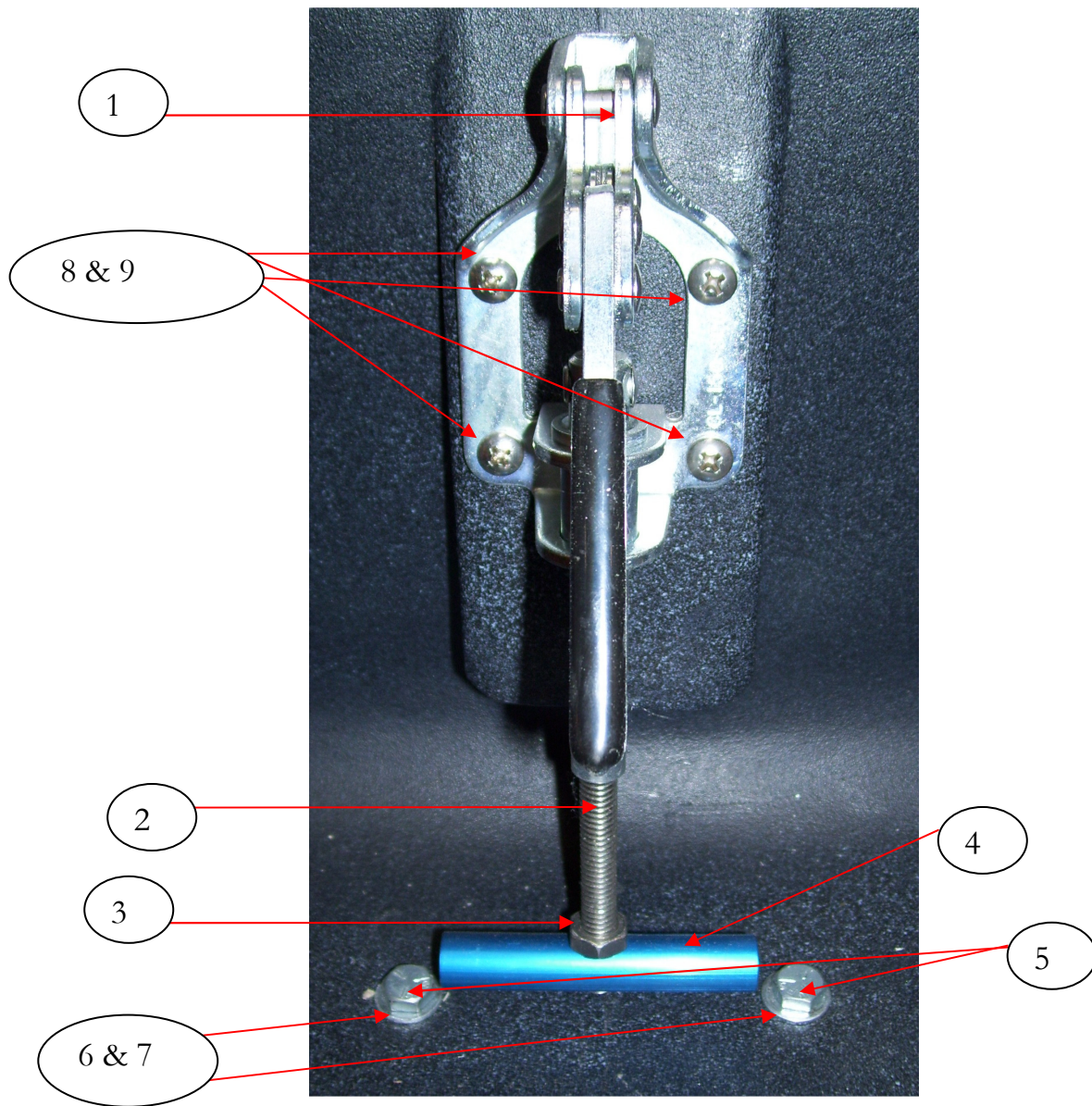

1	CLAMP TOGGLE	NM4245	7	LOCK EASHER 1/4" SS	NM5432
2	STUD 5/16-18 X 2-1/2"	NM4246	8	SCREW 10-32 X 7/8" BHCS SS	NM4240
3	NUT 5/16-18 HEX (Qty 2)	NM4290	9	NUT 10-32 NYLOCK SS	NM4081
4	BAR CARPET CLAMP 1/2" X 3"	NM4247			
5	SCREW 1/4-20 X 1" HXHD SS	NM5034			
6	FLAT WASHER 1/4" SS	NM5066			

**HEATER BOX ASSEMBLY
FRONT VIEW**

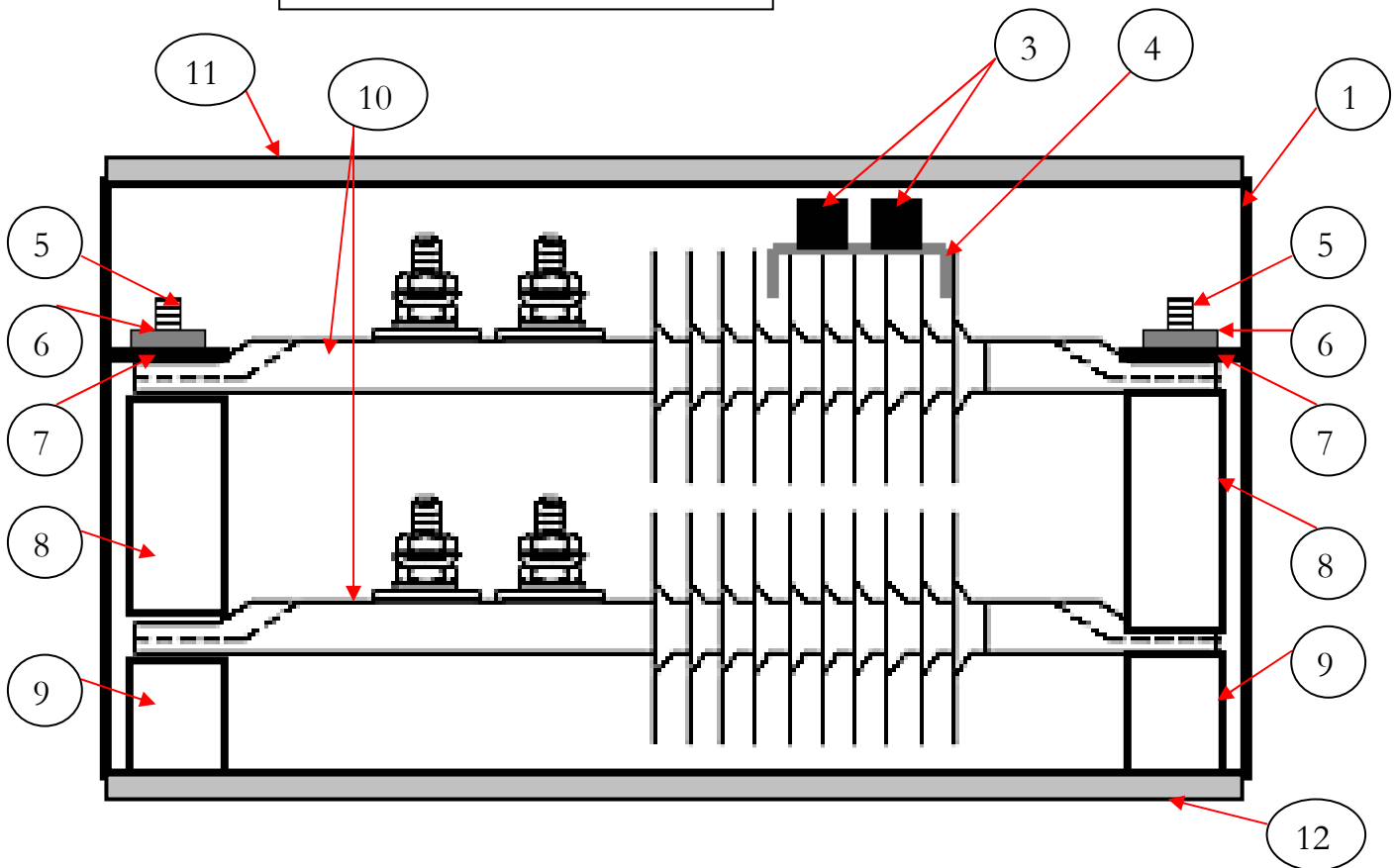

1	HEATER BOX – ALUMINUM LARGE – E-TES SD	NM4415	10	HEATING ELEMENT 17-7/8” 120VAC - 750 WATT (QTY 4)	NM4453
2			11	TOP INSULATION 1/4” X 18” X 9.75” (QTY 2) CERAMIC FIBER PAPER	NM4441A
3	SWITCH 250°F AUTO RESET HI TEMP (QTY 2)	NM4408	12	BOTTOM INSULATION 1/4” X 18” X 9.75” (QTY 2) CERAMIC FIBER PAPER	NM4441B
4	BRACKET TEMP SWITCH MOUNT	NM4418			
5	SCREW 5/16-18 X 3-1/2” PFLTHD SS (QTY 4)	NM4256			
6	NUT 5/16-18 HEX NYLOCK SS (QTY 4)	NM4258			
7	FLATWASHER 5/16” SS (QTY 4)	NM4251			
8	SPACER – TALL PTFE (QTY 4)	NM4461	NS	AIR FLOW SWITCH ASSEMBLY	NM5428
9	SPACER – SHORT PTFE (QTY 4)	NM4459	NS	RIVET 1/8” X 1/8” ALUMINUM (QTY 4)	NS116

AIR FLOW SENSOR ASSEMBLY

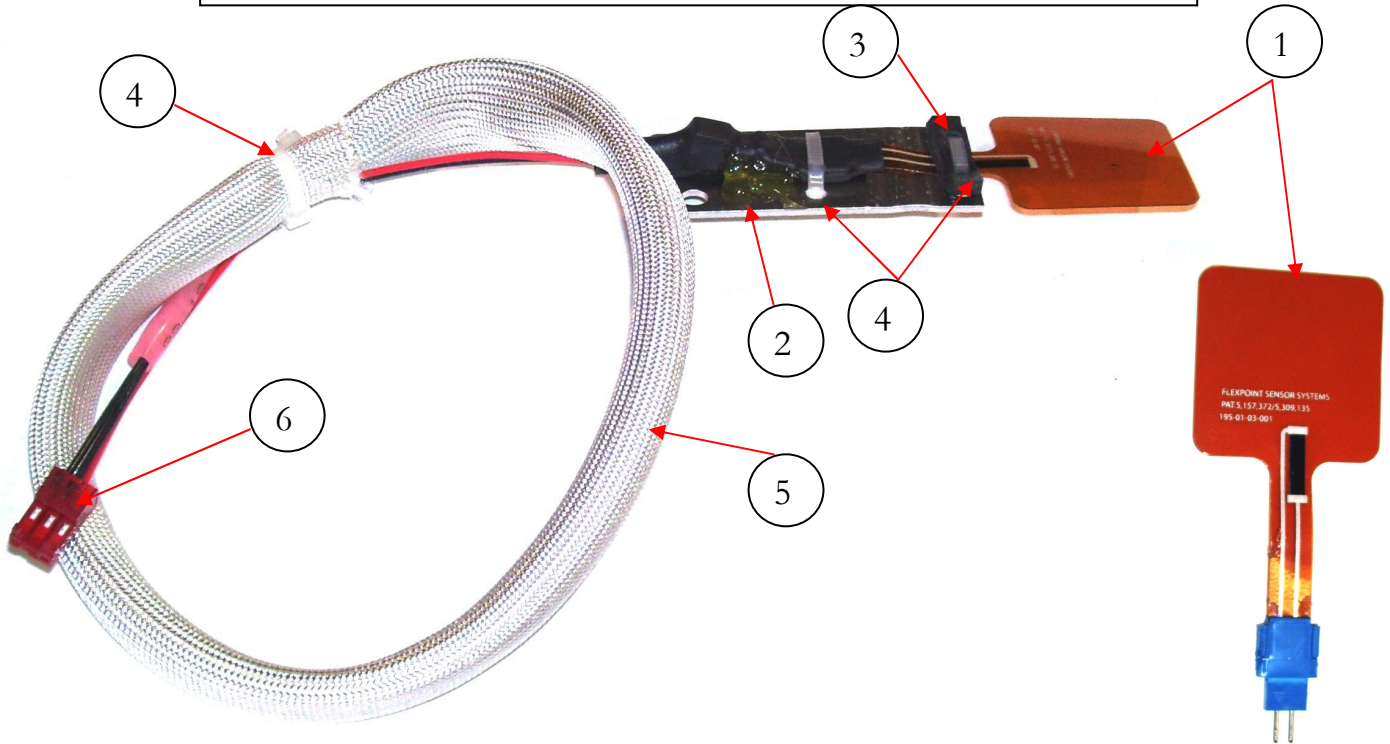

1	AIR FLOW SENSOR W/ CONNECTOR	NM5410
2	BRACKET AIR FLOW SENSOR	NM5414
3	RUBBER GASKET	NM5412
4	WIRE TIE 4"	NM5418
5	FIBERGLASS WIRE GUARD (Sold Per Inch)	NM5420
6	3-PIN FEMALE CONNECTOR	NM5400
	AIR FLOW SENSOR ASSEMBLY W/ CONNECTORS (Includes 1-6 & * items)	NM5428
*	RED WIRE 22 GAUGE (Sold per inch - 19")	NM5404
*	BLACK WIRE 22 GAUGE (Sold per inch - 21")	NM5406
*	2-PIN FEMALE CONNECTOR	NM5402
*	3/8" HEAT SHRINK TUBING	NM5416
*	BUTT CONNECTOR 18-22 GAUGE	

Warranty

Your E-TES SD 120 Volt Electric Thermal Exchanger is designed to give you years of reliable service. If a problem should arise use the troubleshooting section in the operation manual to diagnose and correct the problem if possible. If you are unable to determine the cause or solution to the problem contact your distributor or Bridgepoint Systems for assistance.

Bridgepoint Systems warrants the roto-molded body of the E-TES SD 120 Volt Electric Thermal Exchanger to be free from defects in material or workmanship for five years from the date of purchase.

Warranty coverage does not include damage to body due to overheating after the first year.

All other components of the E-TES SD 120 Volt Electric Thermal Exchanger are warranted to be free of defects in material and workmanship for one year from the date of purchase.

During the warranty period, Bridgepoint Systems will, at its option repair or replace components which prove to be defective.

- This warranty does not provide for replacement of complete units due to defective components.
- Service Labor is only covered for the first 90 days after the date of purchase.
- Any costs for transportation are not covered in this warranty.
- Replacement parts are warranted only for the remainder of the original warranty period.

This warranty **shall not** apply to defects resulting from improper operation, lack of maintenance, condensation, chemical corrosion, unauthorized modification, misuse or abuse.

This warranty **does not** cover normal wear to items such power cords, plug adapters or other items which require replacement as a result of ordinary usage.

To obtain warranty service for the E-TES SD 120 Volt Electric Thermal Exchanger, contact your distributor or Bridgepoint Systems. If the unit must be returned to Bridgepoint Systems or an authorized service center, the purchaser shall prepay shipping charges for products returned for warranty service.

- No returned items will be accepted by Bridgepoint Systems without prior authorization. All returns must have a return authorization number, issued by Bridgepoint Systems, clearly marked on the exterior of the package.

Bridgepoint Systems makes no other warranty either expressed or implied with respect to this product. The remedies provided herein are the purchaser's sole and exclusive remedies.

In no event shall Bridgepoint Systems be liable for any direct, indirect, special, incidental or consequential damages.

This warranty gives you specific legal rights. You may also have other rights which vary from jurisdiction to jurisdiction.